

**8-Position Cat5e (EMT) Modular Plug Connectors**

**NOTE**

All numerical values are in metric units [with U.S. customary units in brackets]. Dimensions are in millimeters [and inches]. Figures and illustrations are for identification only and are not drawn to scale.

**1. INTRODUCTION**

This specification covers the requirements for application of Category 5e (EMT) Modular Plug Connectors. These requirements are applicable to hand or automatic machine terminating tools. Cables approved for use with these connectors are round, twisted-pair cables, shielded or unshielded; with 24-26 AWG stranded conductors. The insulated conductor outside diameters must be between 0,80 and 1,00 mm [.031 and .039] and a cable jacket outside diameter between 4,7 and 7,0 mm [.185 and .275]. See Section 3.2 for cable details.

When corresponding with Tyco Electronics Personnel, use the terminology provided in this specification to facilitate your inquiries for information. Basic terms and features of components are provided in Figure 1.

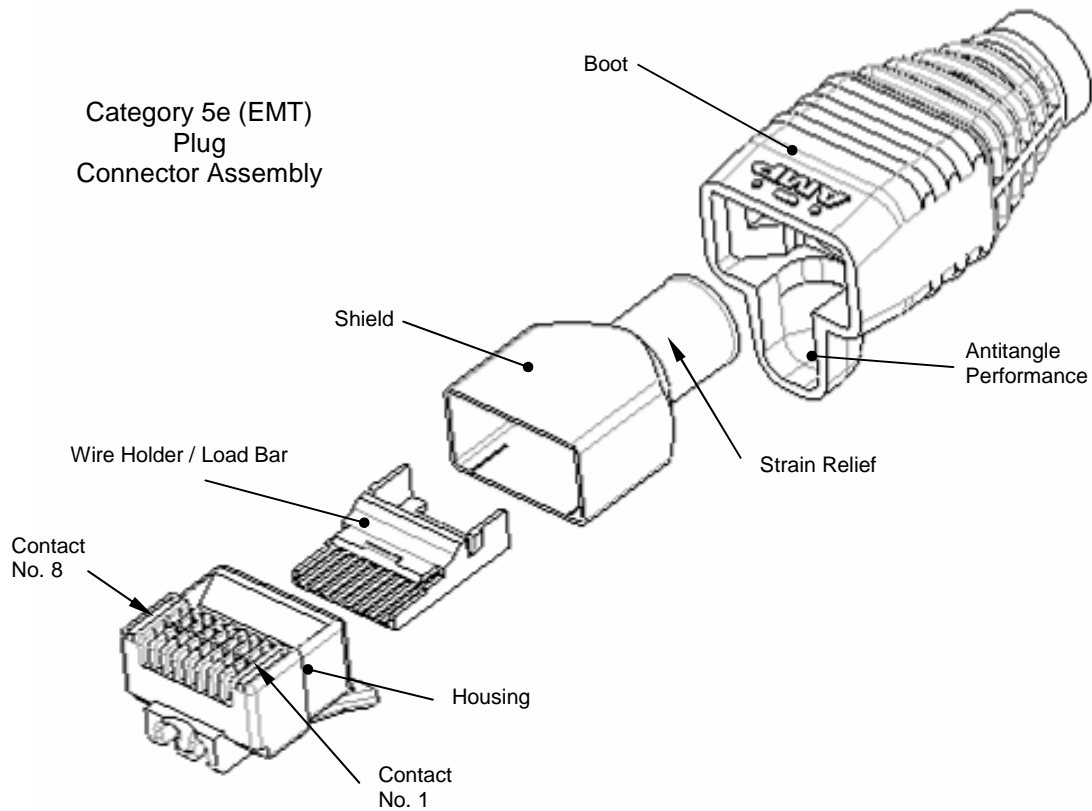

Figure 1: Basic terms and features

## 2. REFERENCE MATERIAL

### 2.1. Revision Summary

This paragraph is reserved for a revision summary of changes and additions made to this specification. The following changes were made for this revision:

- Replaced and updated Figure 9, 10 and 13.
- Rewrite paragraph 3.2.C.7
- Added pn shields 1711393 and 336461 in table Figure 17

### 2.2. Customer Assistance

Reference Base Part Numbers 336330, 336349, 336352, 336462, 336643 and 1711413 are representative numbers of 8-position Category 5e (EMT) Modular Plug Connectors. Use of these numbers will identify the product line and expedite your inquires through a service network established to help you obtain product and tooling information. Such information can be obtained through a local Tyco Electronics Representative (Field Sales Engineer, Field Applications Engineer, etc).

### 2.3. Drawings

Customer Drawings for specific products are available from the responsible Engineering Department via the service network. The information contained in the Customer Drawings takes priority if there is a conflict with this specification or with any other technical documentation supplied by Tyco Electronics.

### 2.4. Specifications

Product Specification 108-19102 provides test results and product performance requirements.

### 2.5. Instructional Material

The following list includes available instruction sheets (408-series) and customer manuals (409-series) that provide operation, maintenance, and repair of tooling. In addition, follow the instructions and procedures outlined in Paragraph 3.2 of this specification for product assembly procedures.

<u>Document Number</u>	<u>Document Title</u>
408-8734	Terminating Modules 791804-[ ] For Use with Modular Plug Dual Terminators
408-8738	PRO-CRIMPER III Hand Tool and Die 790163-[ ] for EMT and Cat6 Mod Plug Connectors
408-9930	PRO-CRIMPER III Hand Crimping Tool Frame Assembly 354940-[ ]
409-10010	Modular Plug Dual Terminator 1320840-[ ]

## 3. REQUIREMENTS

### 3.1. Storage

#### A. Ultraviolet Light

Prolonged exposure to ultraviolet light may deteriorate the chemical composition used in the connector components.

#### B. Shelf Life

All components products should remain in the shipping containers until ready for use to prevent damage.

These products should be used on a first in, first out basis to avoid storage contamination.

#### C. Chemical Exposure

Do not store connector components near any chemicals listed below, as they may cause stress corrosion cracking in the product.

Alkalies	Ammonia	Citrates	Phosphates	Citrates	Sulfur Compounds
Amines		Carbonates	Nitrites	Sulfur Nitrites	Tartrates

#### NOTE

Where the above environmental conditions exist, phosphor-bronze contacts are recommended if available.

### 3.2. Cable

#### A. Cable Specifications

1. Cable Type: Round jacketed, Shielded or Unshielded, 4, 2 or 1 Twisted Pairs (Pairs individually shielded or not)
2. Conductor Type: Stranded conductor, 24-26 AWG, 7-strands.
3. Conductor Insulation Outside Diameter: 0.80-1.00 mm [.031-.039 in.] for any one conductor.
4. Cable Jacket Insulation Diameter: 4,7 - 7,0 mm. [.185 – .275 in.].
5. Shield Type: Foil with drain wire and/or braid, with or without drain wire.
6. Cable Pair Arrangement: The arrangement of colour-coded pairs within the cable jacket applicable to TIA/EIA T568B wiring and the termination procedures described in this specification is shown in Figure 2. Cable end A applies to one end of the cable and cable end B to the opposite end. For TIA/EIA T568A wiring or termination of cables with pair arrangements other than shown in Figure 2, contact the responsible Tyco Electronics Engineering Department.

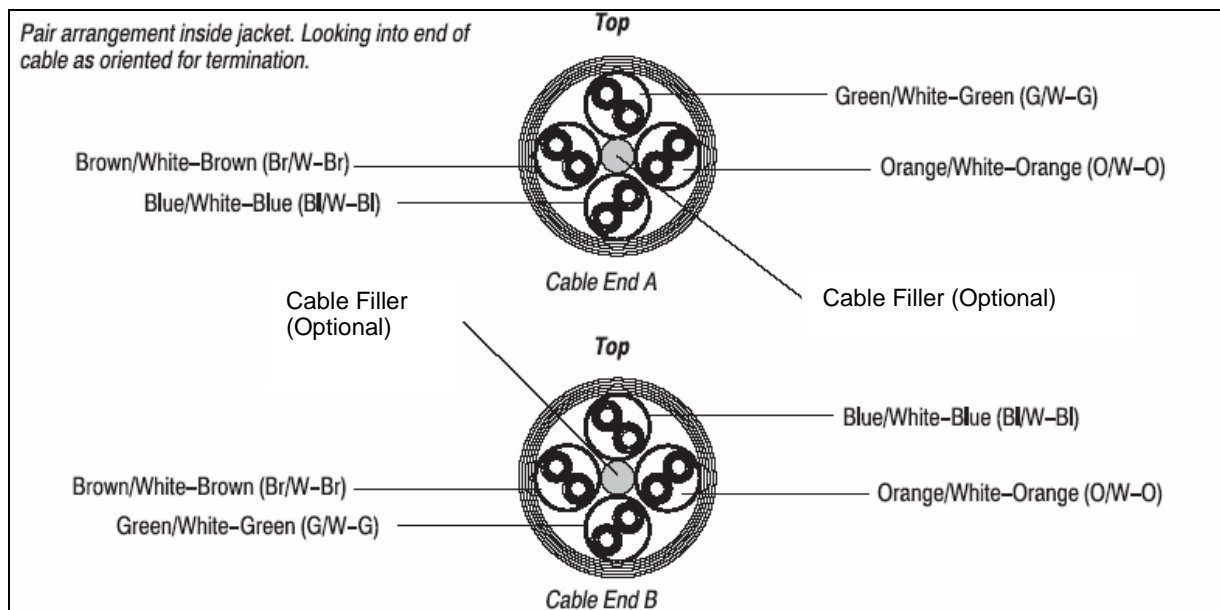

Figure 2

#### B. Cable Preparation (Figure 3)

1. Slide each boot over the relevant end of the cable before the cable stripping operation.
2. Strip the cable jacket 30 - 40 [1.18 – 1.58] as shown.

**CAUTION** Do not nick the insulation of the conductors or the shield of the cable (if present)

3. If the cable is shielded, fold the outside shield and drain wire (if present) back over the jacket. In case of overall braid and foil together, foil must be trimmed up to 2.0 [.079] max from the jacket end. Individual pair shields must be trimmed up to 2.0 [.079] max from the jacket end.
4. If present, cut and remove any cable filler, ripcord or plastic wrap.
5. Slide the plug shield over the cable jacket and cable shield.

**CAUTION** Do not tear the cable shield. Do not slide the plug shield past the folded-back end of the cable shield



	
1. Slide the boot	2. Strip the cable jacket, recommended length 30–40 mm [1.18-1.58]
	
3. Fold the outside shield back over the jacket, In case of braid and foil together, foil must be trimmed up to 2 mm max.	4. Foil of individual pair shields must be trimmed up to max 2mm max.
	
5. Slide the plug shield over the cable jacket and cable shield	

Figure 3: Cable preparation

### C. Cable Positioning

1. While firmly holding the cable jacket next to the stripped end, untwist the pairs as much as possible as shown in figure 4

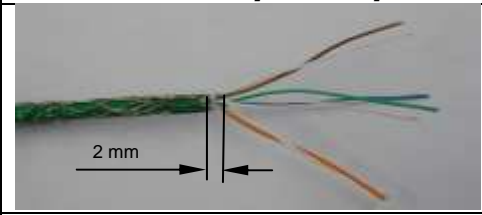
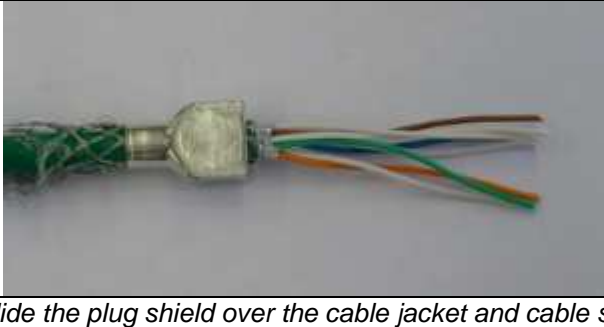
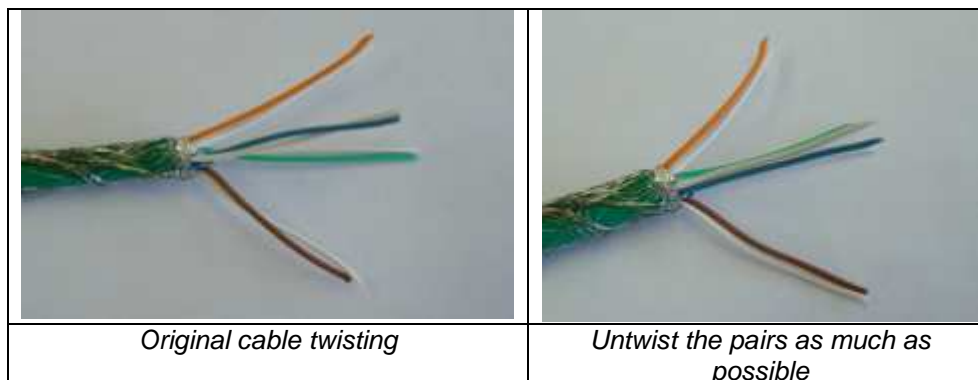

Figure 4

2. Position the pairs according to the right Wiring. Try to avoid twisting between pairs as much as possible. See Figure 5.

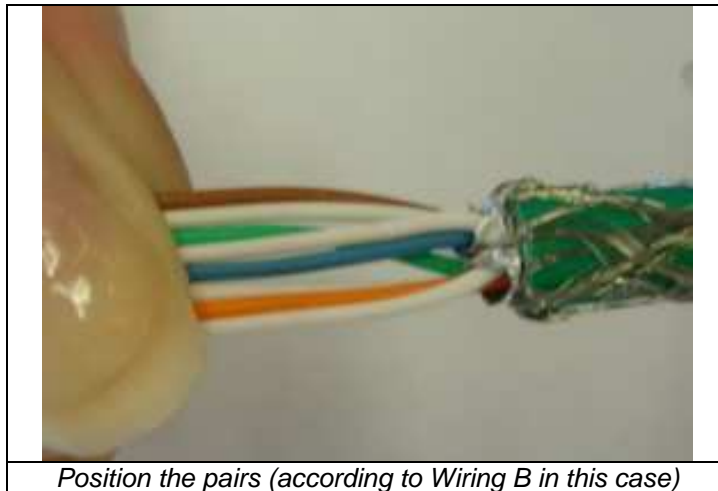

Figure 5

3. While firmly holding the positioned pairs, make a preliminary cut to the pairs to help the insertion of the conductors into the wire holder. See Figure 6.

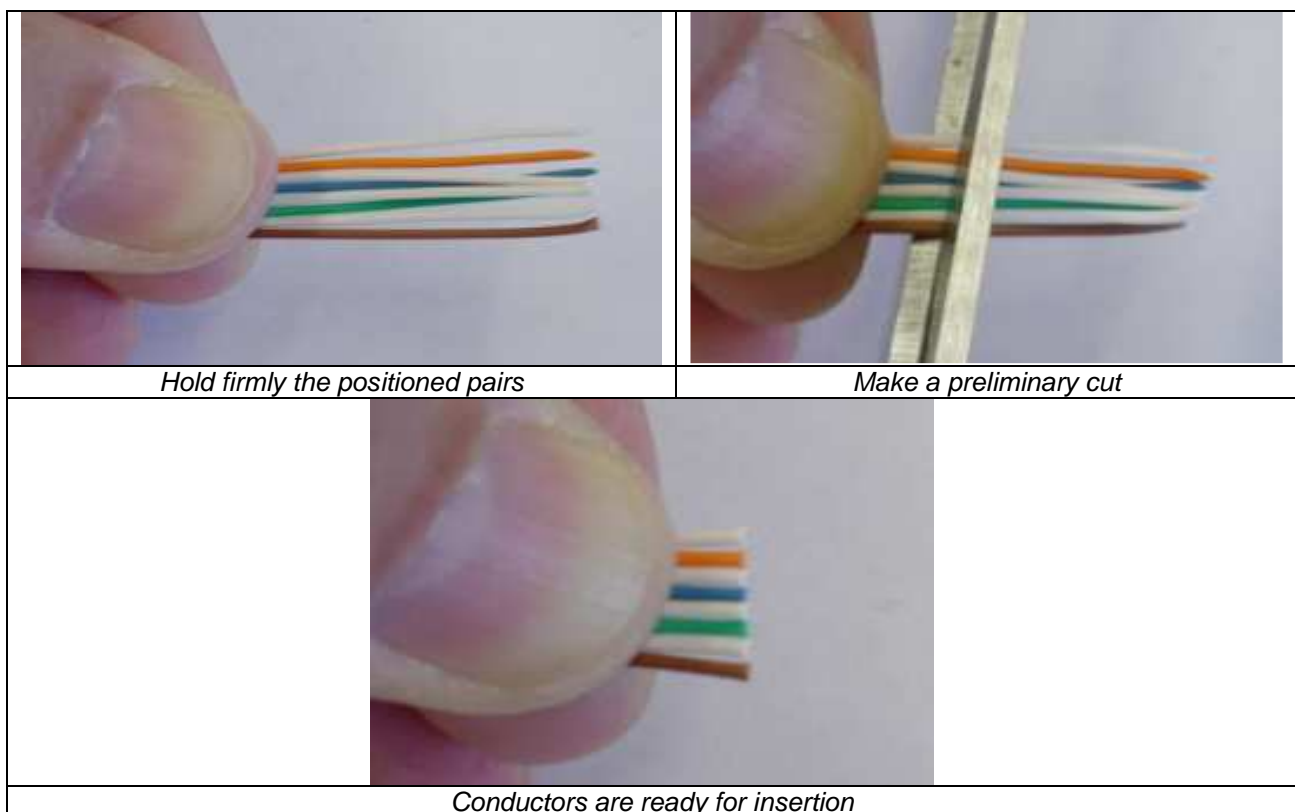

Figure 6

4. Insert the conductors through the wire holder and slide it up to the end. See Figure 7.

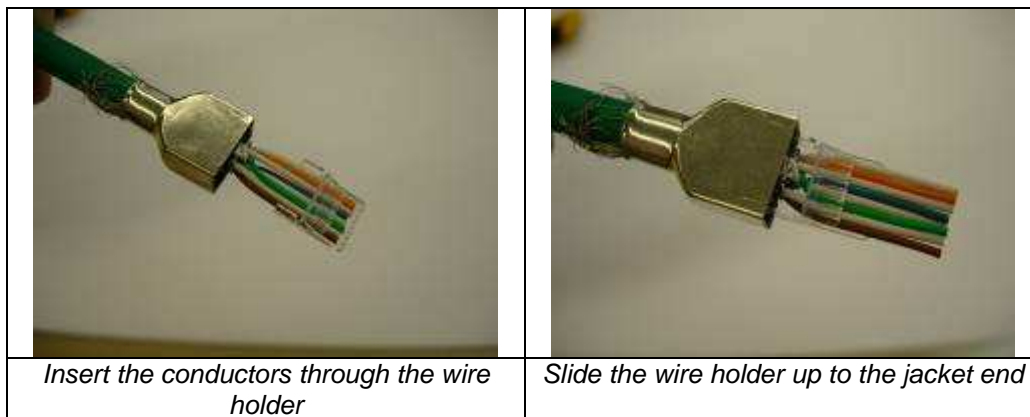

Figure 7

5. While holding all conductors down against the wire holder in a flat layer, trim all conductors evenly and square with appropriate tooling, just beyond the front edge of the wire holder as shown in fig. 8.

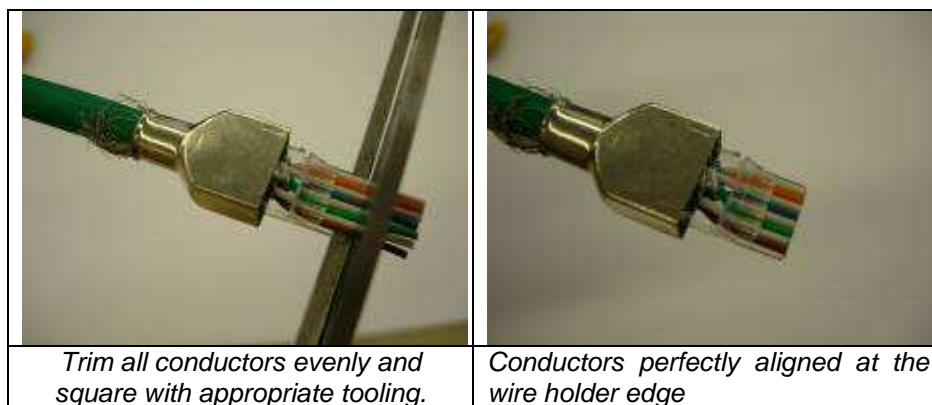

Figure 8

6. Insert the front of the wire holder and the ends of the conductors into the cavity of the plug housing. See Figure 9.

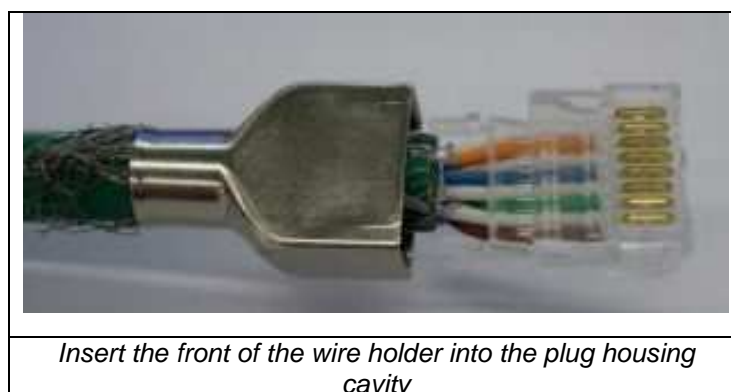

Figure 9

7. Push the wire holder into the housing, making sure it arrives up to the end. See Figure 10.

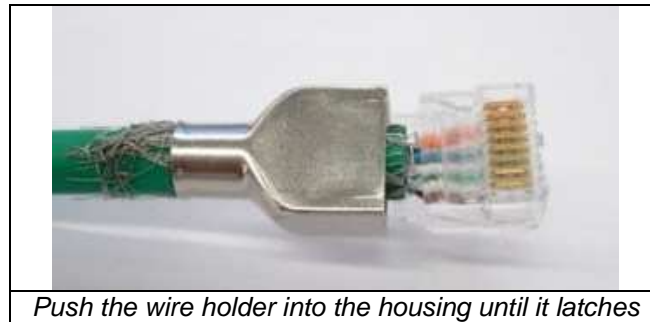

Figure 10

8. Visually verify that all conductors are fully inserted into the housing with the ends of the conductors seated against the end of the housing cavity. If not, push the cable into the wire holder and check if the wire holder has latched into both sides of the plug housing.

**CAUTION**

*Do not rotate the cable relative to the plug and do not allow the wire holder to cock at an angle relative to the plug.*

### 3.3. Connector Termination

Refer to Section 5, TOOLING, for appropriate crimp tooling and machines that are compatible with this connector. Proceed as follows:

1. Slide the plug shield over the plug subassembly until it seats against the front edge of recessed area around the outside of the plug housing. See figure 11.

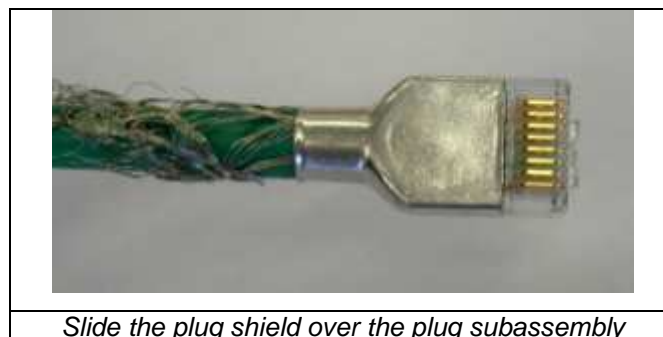

Figure 11

2. Insert the plug and shield assembly into the appropriate tooling and crimp the connector according to the instruction sheet packaged with the tooling. The shield must be free of bulges, tears and must be uniform after the crimping operation.

**CAUTION**

*Continue pushing the cable toward the plug during crimping to ensure that the conductors remain seated against the front of the housing cavity.*

- The shield end must be against the raised edge of the housing. The strain relief end must be held firmly in place on the cable. See Figure 12.

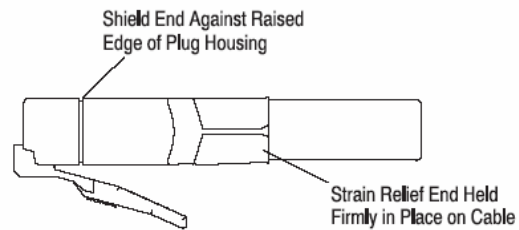

Figure 12

- Trim away any braid/foil and drain wire left extending beyond the end of the plug shield. See Figure 13.

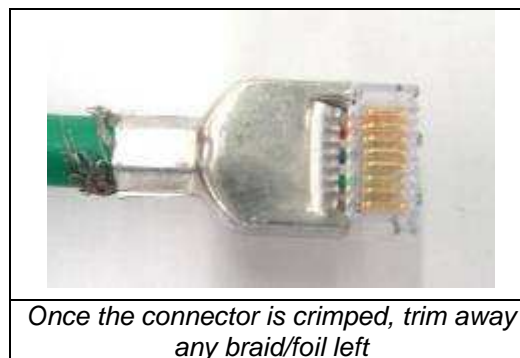

Figure 13

- Slide the boot over the crimped plug and shield. See Figure 14.



Figure 14



### 3.3. Connector Termination Requirements

Figure 15 shows a cutaway of a typical terminated plug and the required location of the conductors. A visual check through the plastic housing of the plug should reveal whether the conductors are within the acceptable range.

For optimum transmission performance, it is preferred that all conductors be fully inserted into the plug housing with the ends of the conductors bottomed against the end of the housing cavity. For reliable electrical termination, the conductors must at least be inserted past the contact and into the 0.80 [.032] reference zone.

Proper crimp height can be inspected using an indicator with needle-point probes or equivalent. The crimp height shall be measured at the front of the contact as shown in Figure 15.

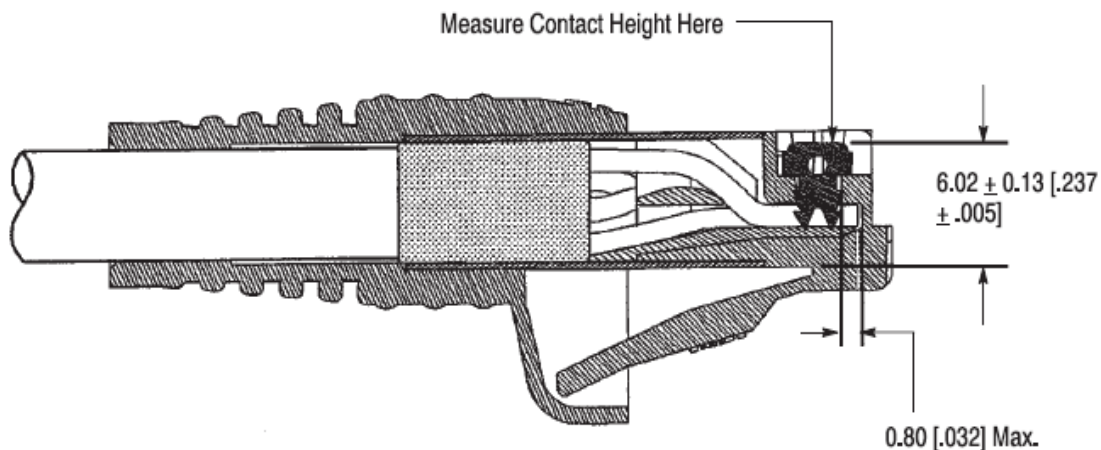

Figure 15: Connector Termination Requirements

In addition make sure that maximum gap between shield and housing is less than indicated in Figure 16.

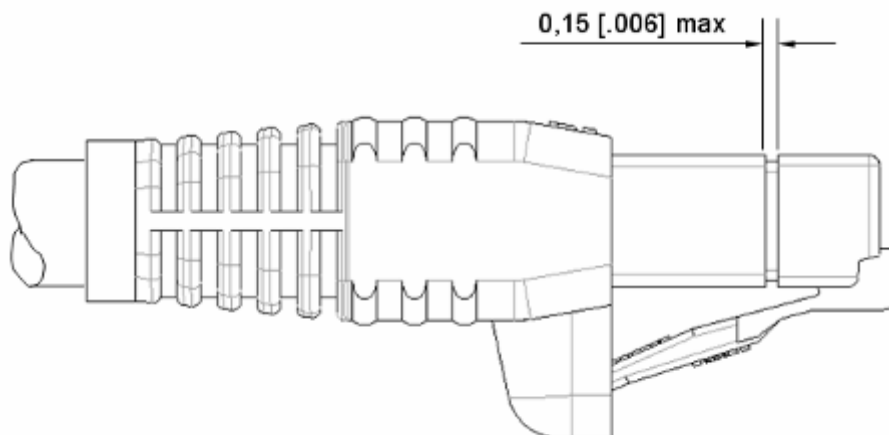

Figure 16: Connector Termination Requirements

### 3.5. Repair/Replacement

Damaged components must not be used. If a damaged component is evident, it must be replaced with a new one.

## 4. QUALIFICATIONS

The Modular Plug Connectors are not required to be Listed or Recognized by Underwriters Laboratories Inc. (UL), or Certified to the Canadian Standards Association (CSA).

### 5. TOOLING

This section provides a selection of tools for termination of the modular plugs. Hand tools are designed for a prototype applications, field terminations, and low volume production. Automatic machines are designed for high productivity cable assembly terminations. Refer to Figure 17 for available termination tooling (and instructional material).

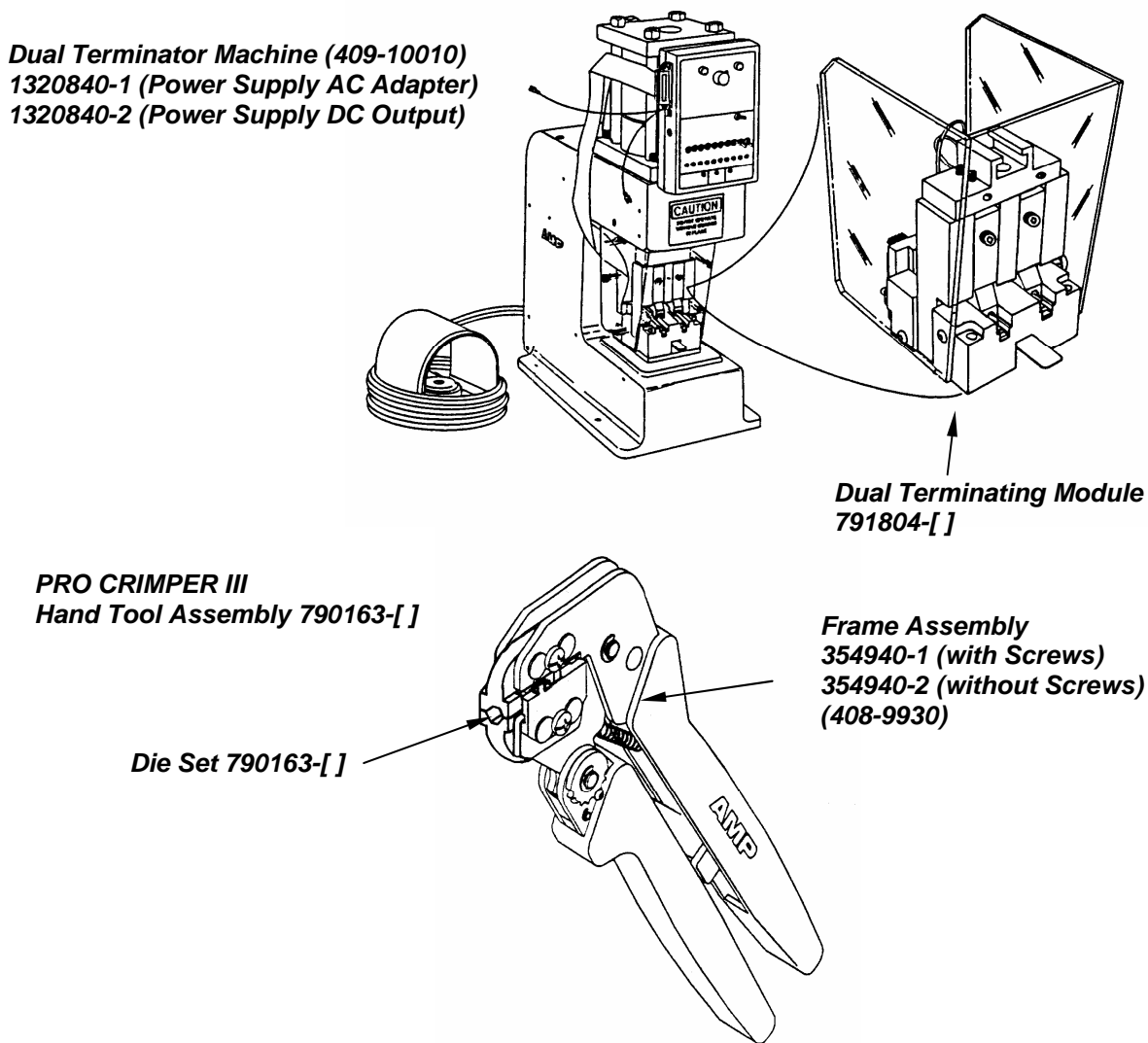

CAT5E (EMT) AND CAT6 PLUG CONNECTOR THAT ACCEPTS CABLE O.D.	HAND TOOL (DOCUMENT)		DUAL TERMINATOR (DOCUMENT)	
	PRO-CRIMPER III HAND TOOL ASSEMBLY	DIE SET ONLY	TERMINATING MODULE	DUAL TERMINATOR
4,7 - 5,3 [.185 - .209] (with shield 1711393-x)	790163-7 (408-8738)	790163-8	791804-4 (408-8734)	1320840-[ ]
5,0 - 6,0 [.197- .236] (with shield 737891-x)	790163-1 (408-8738)	790163-2	791804-1 (408-8734)	1320840-[ ]
5,0 - 6,0 [.197- .236] (with shield 336348-x)	790163-3 (408-8738)	790163-4	791804-2 (408-8734)	1320840-[ ]
6,0 - 7,0 [.236 - .275] (with shield 336461-x)	790163-5 (408-8738)	790163-6	791804-3 (408-8734)	1320840-[ ]

Figure 17: Tooling

## 6. VISUAL AID

Figure 18 shows typical applications of Modular Plug Connectors. These illustrations should be used by production personnel to ensure a correctly applied product. Applications which DO NOT appear correct should be inspected using the information in the preceding pages of this specification and in the instructional material shipped with the product or tooling.

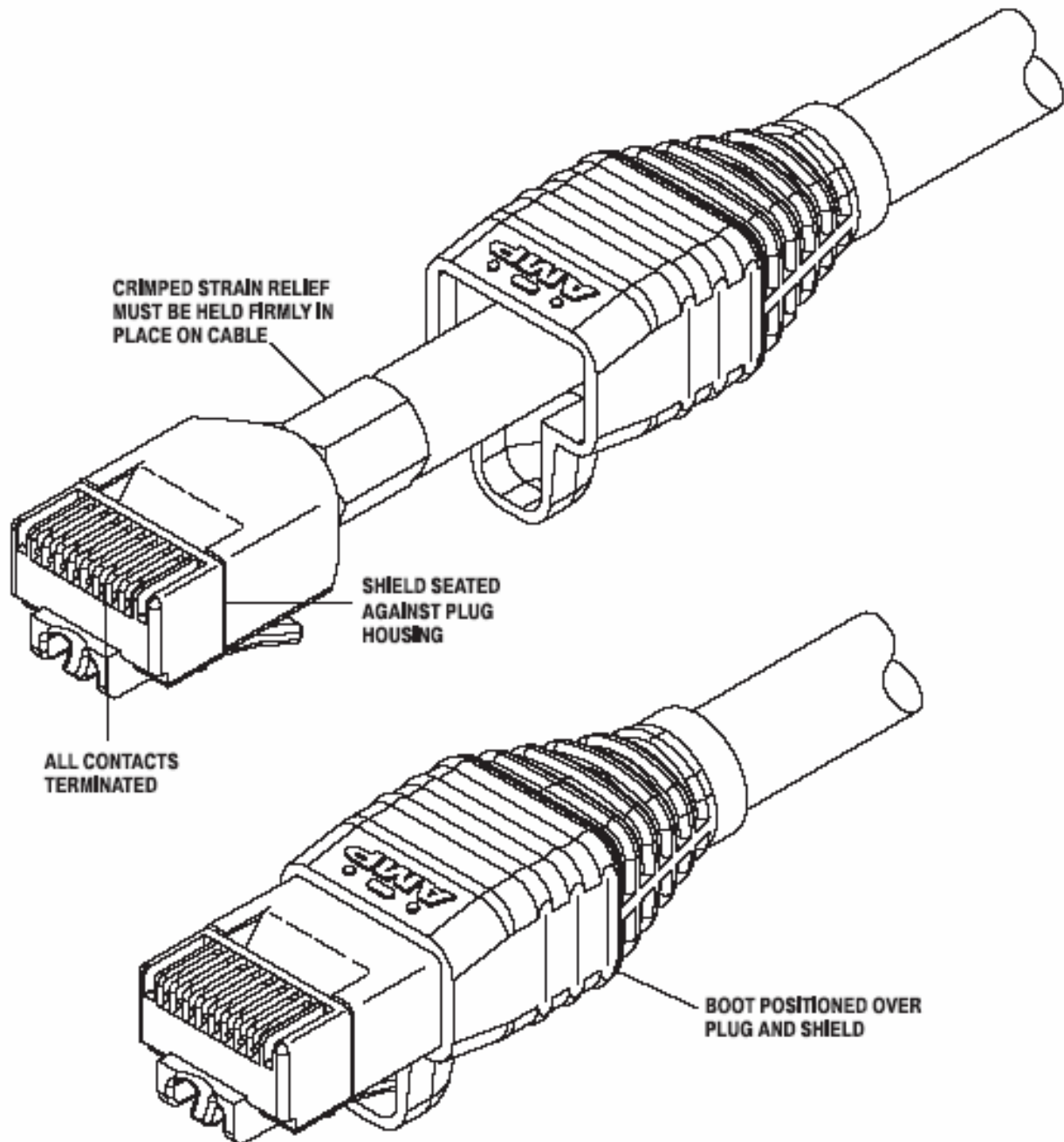

Figure 18: Visual Aid