



**SIDE-POWER**  
Thruster Systems

**SXP SERIES**

# THRUSTER USER MANUAL

Keep this  
manual onboard!

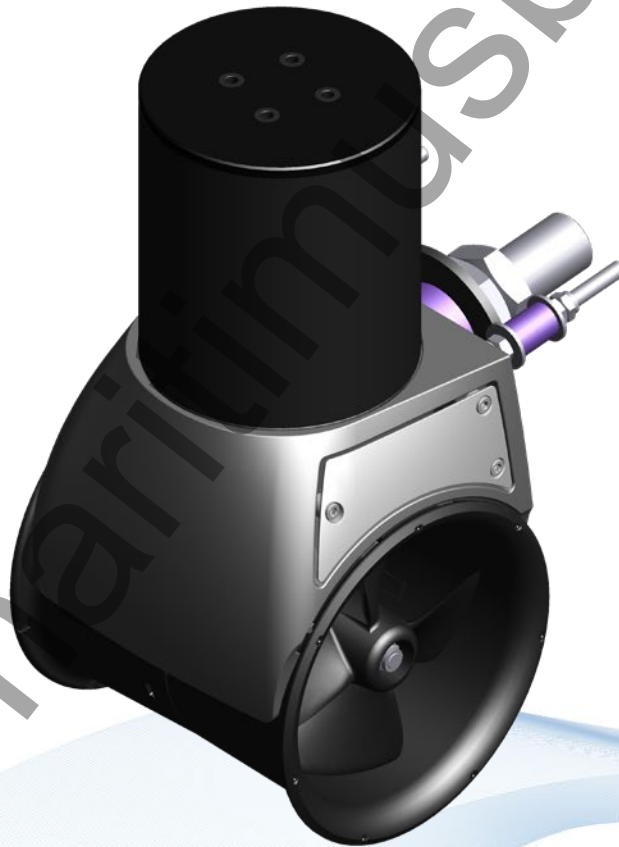

To download your language go to [www.side-power.com](http://www.side-power.com)



**SLEIPNER MOTOR AS**  
by  
[www.maritimusboote.de](http://www.maritimusboote.de)

Document id: 5925

Revision: 5

Date: 2019



Made in Norway

© Sleipner Motor AS 2019

**Product Information**

User Considerations and Precautions .....	3
Thruster Operation .....	4
Control Panel.....	5
Proportional Thruster Display .....	6
Proportional Thruster Display Symbols .....	7
HOLD Function.....	8
Calibration .....	8
Warning Signals When Using 'HOLD' Function.....	8
MENU System.....	9
Alarm Descriptions .....	10 - 11
PHC-3 Alarm Descriptions.....	12 - 13
PDC-301 Alarm Descriptions.....	13
Maintenance.....	14- 15
Troubleshooting - DC series .....	16
Seasonal Checklist.....	17

<b>Spare Parts .....</b>	<b>18</b>
--------------------------	-----------

<b>Warranty statement .....</b>	<b>18</b>
---------------------------------	-----------

<b>Identifying your Product.....</b>	<b>19</b>
--------------------------------------	-----------

**DECLARATION OF CONFORMITY**

MC\_0020



Sleipner Motor AS  
P.O. Box 519, Arne Svendsensgt. 6-8  
N-1612 Fredrikstad, Norway

Declare that this product with accompanying standard control systems complies with the essential health and safety requirements according to:

DIRECTIVE 2013/53/EU  
DIRECTIVE 2014/30/EU  
DIRECTIVE 2014/35/EU

**IMPORTANT**

**Failure to follow the Considerations and precautions can cause serious injury / damage and will render all warranty given by Sleipner Motor AS VOID.**

- Ensure you know the location of the main battery switch that disconnects the thruster from all power sources (batteries) so the thruster can be turned off in case of serious malfunction.
- Always turn the main power switch off before touching any part of the thruster, An incidental start while touching moving parts can cause serious injuries.
- Always turn the control device off when the thruster is not in use.
- The maximum continuous run time of the electrical thruster is approximately 3 minutes. The electromotor has a built-in thermal cut-off switch that will shut off the electro-motor if it is overheating and re-engage when it has cooled down. Consider this when planning your manoeuvring.
- As above the thruster will limit its total running time per period. Do not count on the thruster to hold you in a strong current or side wind for extensive periods. Depending on the surrounding temperatures etc. the thruster will be able to run approximately 10 % of the time.
- Never use thrusters close to objects/ persons or animals in the water, as the thruster will draw objects into the tunnel and contact with the rotating propellers will cause serious injuries and damage the thruster.
- With the boat on land, only run the thruster for a fraction of a second, as without resistance it will accelerate very fast to a potentially damaging rpm.
- While the thruster is in the air, ensure that the propellers have come to a complete stop before performing a directional change of the thruster, as it might cause damage to the thruster.
- If the thruster stops giving thrust while the electro-motor is running, there is possibly a problem in the drive system. You must immediately stop running the thruster and turn it off. Running the electromotor for more than a few seconds without resistance from the propeller can cause serious damage to the electromotor.
- When leaving the boat always turn off the main power switch for the thruster.
- We advise keeping the main engine(s) running while using the thruster. This will keep the batteries in a good charge condition. It will also give better performance to the thruster, a higher voltage at the thruster results in a higher torque (power) in the electromotor.
- Please note the performance of the thruster strongly depends on the voltage available at the electromotor. This voltage will decrease over time because ageing batteries have reduced capacity. Installing new batteries will bring back the thruster to the original level.
- Ensure only one control is used at the same time, if two panels are operated in opposite directions at the same time the thruster will not run. If both are operated in the same direction, the thruster will run in this direction.
- If the thruster is not performing or functioning as usual, the cause must be found and corrected as soon as possible to avoid causing any other or further damage to the equipment. You must also turn off the main battery switch immediately in case the problem is of electric origin.
- Never store items (e.g. equipment, sails, ropes etc.) in the same compartment as the thruster. When the thruster runs for an extended period, it can reach 100°C and will cause damage to nearby items. The electromotor will generate some carbon dust so any storage compartment must be separated from the thruster to prevent nearby items from becoming dusty/ dirty. Any loose items near the thruster motor can cause problems with electrical wiring coming loose and short-circuiting.
- The electromotor, its components, contacts/ plugs or other joints in the control cables must be mounted so they will remain dry at all times.
- It is the owner/ captain/ other responsible parties full responsibility to assess the risk of any unexpected incidents on the vessel. If the thruster stops giving thrust for some reason while manoeuvring you must have considered a plan on how to avoid damage to persons or other objects.
- The primary purpose of the thruster is to manoeuvre/ dock the vessel. Forward/ reverse speed must not exceed 4 knots when operated.

**! Please refer to the graphic for special considerations relating to your model !**

Take time to practice operation in open water to become familiar with the thruster and to avoid damages to your boat or people.

#### How to use a Bow Thruster

1. Turn on the main power switch for the bow thruster. **(NB: Always turn off the main power switch when not onboard.)**
2. Turn on the control panel by pushing both "ON" buttons on the original Side-Power panel simultaneously. **(NB: If another type of control is installed, push the On/Off switch for the bow thruster.)**  
\* Turn off the control panel by pushing both "OFF" button
4. To Turn the bow in the desired direction push the red button for port movement or the green button for starboard.  
- For joystick control, move the joystick in the direction you wish the bow to move.  
- Other controls like footswitches or toggle-switches on the throttle can be used. Engage the port control, the bow will turn to port etc.
5. Depending on the sideways speed of the bow, you must disengage the control device shortly before the bow is in the desired position. **(NB: The boat will continue to move after disengaging the thruster control.)**

#### How to use a single stern thruster

Due to space limitations, a vessel may only have a stern thruster. In this case, the stern thruster is used in the same way as a single bow thruster for moving the boat's stern. Follow the above instruction for operation use.

#### How to use a combined bow and stern thruster

The combination of a bow and stern thruster offers total manoeuvrability to the boat and the ability to move the bow and the stern separately from each other. This enables you to move the boat sideways in both directions and turn the boat around its axis 360° staying stationary.

#### Proportional control thruster

The overall operation of the thruster is the same as above. For proportional control move the joystick equivalent to the amount of thrust you intend to receive.

**NB: At any significant cruising speed (+1-2 kn) the side thruster will have little effect to steer the vessel.**

PRO proportional CONTROL PANEL



PJC221

PJC222

PJC211

PJC212

\*Developed for Hydraulic Thrusters  
Compatible for all DC and AC thrusters

# Proportional Control Panel

\*Developed for Hydraulic Thrusters  
Compatible for all DC and AC thrusters

\*Developed for DC and AC Thrusters  
Not compatible for hydraulic thrusters

Holding function for auto running the thrusters together in the direction of the arrows at selected power Press "+" for more and "-" for less power.

Holding function for auto running the thrusters together in the direction of the arrows at selected power Press "+" for more and "-" for less power.

Press and hold "ON" button for 1 second to activate control panel.

Press and hold for 3 second to activate menu.



Speed control joystick for bow thruster

Speed control joystick for stern thruster

Information display, see following pages for details.

Press to deactivate control panel or cancel or go back in the menu system or to mute internal alarm buzzer.

Emergency stop button

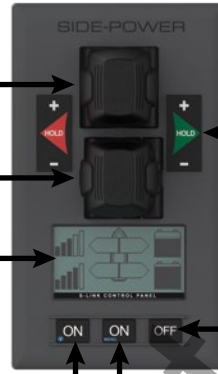

Press and hold both "ON" button for 1 second to activate control panel.

Press and hold for 3 second to activate menu.

Press to deactivate control panel or cancel or go back in the menu system or to mute internal alarm buzzer.

Activating the bow thruster

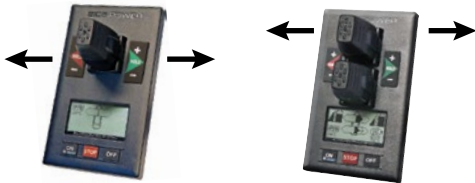

\*Control panel example



Activating the stern thruster



\*Control panel example

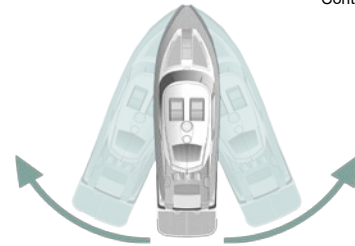

Activating both bow and stern thruster to push the boat sideways



\*Control panel example

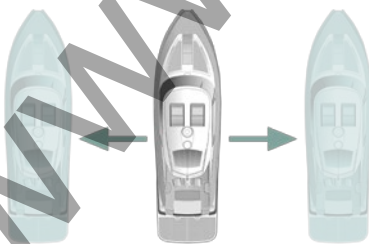

Activating both bow and stern thruster to rotate the boat on axis



\*Control panel example

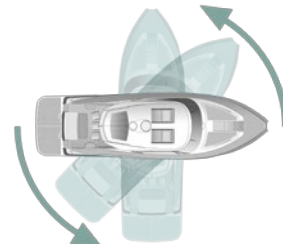



PJC221



PJC222



PJC211



PJC212

Status indicators for bow thruster. (Port bow thruster in a dual bow thruster setup).

Runtime indicator will be shown here in a single DC electric bow thruster setup.

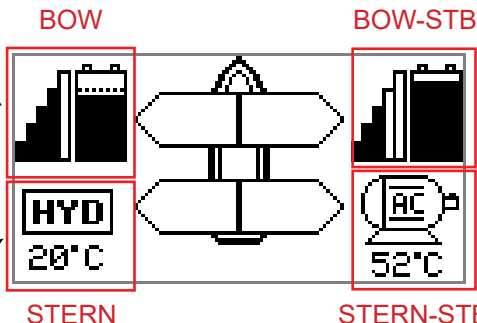

Status indicators for starboard bow thruster. Only shown in a dual bow thruster setup.

Battery indicator will be shown here in a single DC electric bow thruster setup.

Status indicators for stern thruster. (Port bow thruster in a dual stern thruster setup)

Runtime indicator will be shown here in a single DC electric stern thruster setup.

Status indicators for starboard stern thruster. Only shown in a dual stern thruster setup.

Battery indicator will be shown here in a single DC electric stern thruster setup.

Examples of display view for different panels applications:

**PJC211:**  
DC Electric Bow thruster

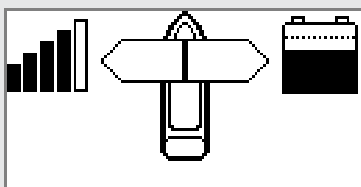

**PJC221:**  
Hydraulic Bow thruster

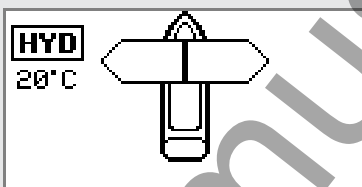

**PJC221:**  
AC Electric Bow thruster

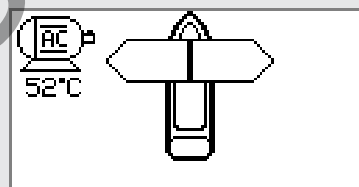

**PJC211:**  
DC Electric Stern thruster

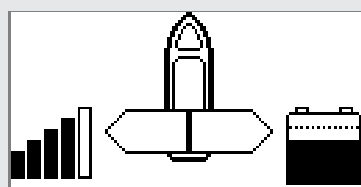

**PJC221:**  
Dual AC Electric Bow thrusters

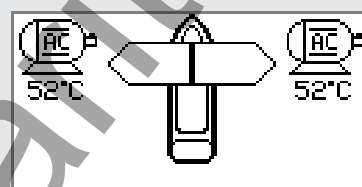

**PJC221:**  
Dual Hydraulic Bow thrusters

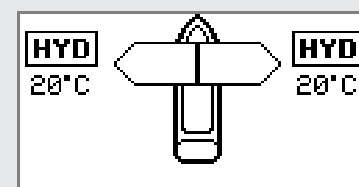

**PJC212:**  
DC Electric Bow thruster  
DC Electric Stern Thruster

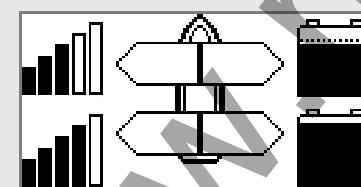

**PJC222:**  
Hydraulic Bow thruster  
Hydraulic Stern Thruster

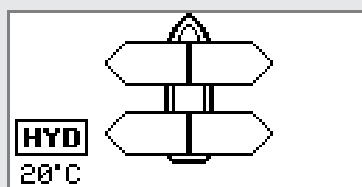

**PJC222:**  
AC Electric Bow thruster  
Hydraulic Stern Thruster

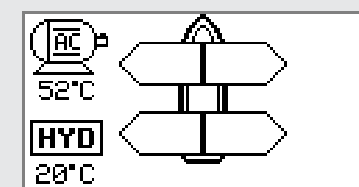

**PJC212:**  
Dual DC Electric Bow thrusters  
Dual DC Electric Stern thrusters

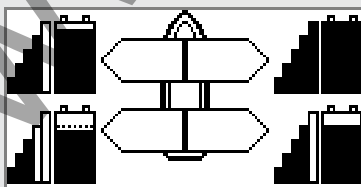

**PJC222:**  
Dual Hydraulic Bow thrusters  
Dual Hydraulic Stern thrusters

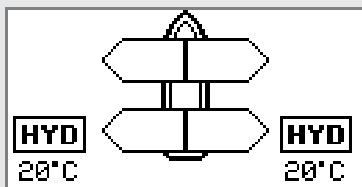

**PJC222:**  
Dual AC Electric Bow thrusters  
Dual AC Electric Stern thrusters

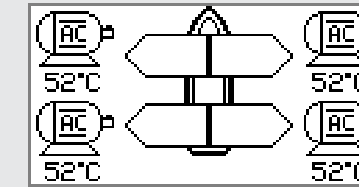

**DC Thrusters:**

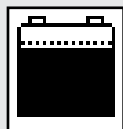

Battery indicator.  
From 8.5V to 12V for 12V thrusters,  
15V to 24V for 24V thrusters

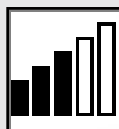

Motor temperature indicator.  
From 70°C/ 158°F to 130°C/266°F.

Symbol shown when a DC Thruster is used in a dual bow or dual stern setup:

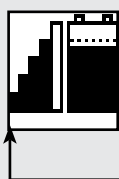

Battery indicator.  
From 8.5V to 12V for 12V thrusters,  
15V to 24V for 24V thrusters

Motor temperature indicator.  
From 70°C/ 158°F to 130°C/266°F.

**AC Thrusters:**



Motor temperature indicator.

**Hydraulic Thrusters:**



Hydraulic oil temperature indicator.

**Retractable Thrusters:**



Symbol shown when the thruster deploys.



Symbol shown when the thruster retracts.



Symbol shown when the thruster is in position OUT.

When the thruster is deployed and no input is given via the joysticks/buttons over a 10 second period, the panel will give an audible signal every 10th second to tell that the thruster is still deployed.

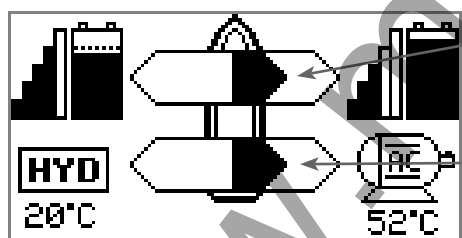

**Thrust power and direction, Bow thruster(s)**

Input from bow joystick on this panel.  
The thrust indicator will be shown in this position on a single joystick panel if the thruster is defined as a bow thruster

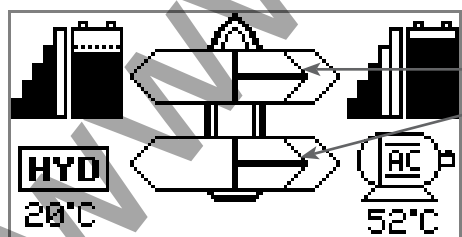

**Thrust power and direction, Stern thruster(s)**

Input from stern joystick on this panel  
The thrust indicator will be shown in this position on a single joystick panel if the thruster is defined as a stern thruster.

Indicating amount of thrust set by other control units in the system, i.e additional PJC panels, 8700 Retract panel, input via 8730 S-link external switch interface, S-link remote control etc.

If two or more units are set to run the thruster in opposite direction, this information will not be shown.



The 'HOLD' function is for auto-running of bow and stern thrusters together in the direction of the arrows at selected power.

Press "+" for more and "-" for less power (6 steps). The 'HOLD' function is normally used to hold the boat into the dock while mooring. The 'HOLD' function can be deactivated by running any thruster in the opposite direction from any control unit.

The 'HOLD' function can be calibrated to get balanced thrust from the bow and stern thruster.

See the PJC control panel manual on how to calibrate.

**For safety!** When oil pressure goes below 10bar, the 'HOLD' function is deactivated.

**The internal and external (if fitted) buzzer will give the following warning signals:**

	Warning signals	Cause	Effect
1.	Single short beep every 2.4 sec.	<ul style="list-style-type: none"> <li>Voltage below 9.3V/17.5V (12V/24V system).</li> <li>Temperature above 85°C/185°F.</li> </ul>	None
2.	Two short beeps every 2.4 sec.	<ul style="list-style-type: none"> <li>Voltage below 8.9V/16.3V (12V/24V system).</li> <li>Temperature above 100°C/212°F.</li> </ul>	None
3.	Red backlight in display and continous short beeps.	<ul style="list-style-type: none"> <li>Voltage below 8.5V/15V (12V/24V system).</li> <li>Temperature above 110°C/230°F.</li> </ul>	None
4.	Red backlight in display and continous short beeps.	If one or more of the thrusters enters an alarm state - Voltage below 8.0V/12.0V (12V/24V system) or temperature above 120°C/248°F.	"HOLD" function are cancelled and both thrusters will stop. Temperature must drop below 110°C/230°F before the thruster can be operated again. Low Voltage alarm must be reset from panel.



- Move around in menus by using joystick.
- Follow instructions on the screen and press the buttons below the symbols indicated on LCD screen.
- Access menu system by pressing and holding Menu button for 3 seconds.

**MAIN MENU ITEMS:**

Move between main menu items with the (stern) joystick.

LANGUAGE	STABILIZER	SETUP	INFO	DEFAULT SETTINGS	PANEL SETUP
Language	Stabilizer (If installed)	Setup	Info	Default settings	Panel setup

**BUTTON SYMBOLS**

On the bottom line of the display, a symbol will be shown over the buttons below. These symbols will show what function each corresponding button has in the selected menu entry.

Return to previous menu.	Select highlighted menu text / Save edited parameter.	Edit highlighted parameter.	Cancel editing without saving.	This symbol indicates that the (stern) joystick is used to move between menu items / parameters.



**LANGUAGE**

- Choose language by moving joystick: English, Norwegian, German, French, Spanish, Italian and Danish.
- Press the button below to set the language to the highlighted menu entry. A star (\*) on each side indicates the language set.

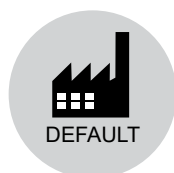
**DEFAULT SETTINGS**

- Reset all settings to factory default - follow instructions on screen
- Press the button below to confirm reset
- The following parameters/values will be set to the factory settings:

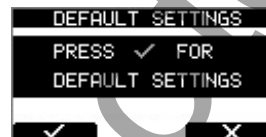

Language = English  
 Backlight Level = 5  
 Backlight Night Color = Green  
 Backlight Nightlevel =1  
 Timer Auto-Off = 05 min  
 Hold Calibration =70% Bow and Stern

All system devices will be erased from memory.  
 (Setup procedure must be followed to reconfigure the system)



(Default in systems with stabilizers)

**STABILIZER**

(Shown only for yachts equipped with a Side-Power Stabilizer system)

- Press the button below to edit the selected parameter. ON/OFF will start to blink, use joystick to alter value.  
 Press the button below to save edited parameter to device.

**1. Stabilizer:**

- Values: ON/OFF
- Switches the stabilizer ON or OFF.

**2. AnySpeed:**

- Values: ON/OFF
- Switches the zero speed/at anchor stabilization ON or OFF.



"Err. No."	Errors shown in display	"Auto Reset"	"Ext. buzzer activation at Alert Level"	Description	Action
1	Motor Overcurrent		2 <sup>(2)</sup> , 3	Motor current too high.	"Thruster must be serviced by authorized personnel, reset or power OFF/ON PPC <sup>(1)</sup> ."
2	Motor Overtemp	Yes	2 <sup>(2)</sup> , 3	"Motortemp has been over 120°C/248°F."	Motor cool down below 110°C /230°F.
3	Controller Overtemp		2 <sup>(2)</sup> , 3	"PPC <sup>(1)</sup> temp has been over 80°C/176°F."	PPC <sup>(1)</sup> cool down below 45°C/113°F.
4	Controller Overtemp		2 <sup>(2)</sup> , 3	"SR150000 temp has been over 80°C/176°F."	SR150000 cool down below 45°C /113°F.
5	Low Voltage		2 <sup>(2)</sup> , 3	Low motor voltage alarm when motor is running. 12V thruster below 8.00V 24V thruster below 12.00V	Recharge battery, reset or power OFF/ ON device.
6	Thermoswitch	Yes	2 <sup>(2)</sup> , 3	Thermo switch input is activated and there is an open circuit.	The thruster needs to cool down before operating again.
7	IPC Error		2 <sup>(2)</sup> , 3	Motor relay fault	"Turn off thruster battery main switch. Thruster must be serviced by authorized personel."
8	Critical Error		2 <sup>(2)</sup> , 3	PPC <sup>(1)</sup> output fail	PPC <sup>(1)</sup> must be sent for service.
9	Low Motor Current		2 <sup>(2)</sup> , 3	Thruster uses no power	Check thruster connections or motor dead!
10	Motor Contactor		2 <sup>(2)</sup> , 3	No current on motor relay coil.	Check motor relay connections, short circuit or relay dead!
11	System Error		2 <sup>(2)</sup> , 3	Fatal error	Device must be serviced by authorized personel
12	No Communication		2 <sup>(2)</sup> , 3	No communication with device	Check S-Link cables and power connections.
13	Motor Temp Sensor		2 <sup>(2)</sup> , 3	Motor temperature sensor fail	Check for an open circuit on the temp sensor on the motor
14	Supply Voltage Fault		2 <sup>(2)</sup> , 3	No power	Check power connections
15	Fuse Blown		2 <sup>(2)</sup> , 3	Fuse blown	Replace fuse or check if main cable from battery and main cable to thruster has been switched
16	Manual Override	Yes	2 <sup>(2)</sup> , 3	Main switch manually overridden	Pull main switch
17	Motion OUT Fault		2 <sup>(2)</sup> , 3	Retract obstructed while deploying	Turn off all panels. Go for lower speed/ deeper water and retry.
18	Motion IN Fault		2 <sup>(2)</sup> , 3	Retract obstructed while retracting	Turn panel on and manually override main switch. Remove obstruction and try again.

1. PPC520, PPC820, PPC800, PPC840

2. Buzzer is only activated when any device is sending thrust on the S-link bus.

"Err. No."	Errors shown in display	"Auto Reset"	"Ext. buzzer activation at Alert Level"	Description	Action
19	Actuator Fault		2 <sup>(2)</sup> , 3	Actuator not getting any power	"Check actuator connection or power to actuator. Reset alarm in alarm menu on PJC 211/212/221/222 or recycle power."
20	Pos.Sensor Fault		2 <sup>(2)</sup> , 3	Retract position sensor fail	Check position sensor cables and for sensor damage.
21	In Service Mode	Yes	2 <sup>(2)</sup> , 3	"Retract controller in service mode. Switch no. 4 is ON."	Check dipswitch setting on retract control box.
22	High Oil Temp	Yes	1, 2 <sup>(2)</sup> , 3	"Hydraulic oil temperature is higher than 75°C /167°F."	"Stop running and wait for temperature to drop. Check if cooling pump is running."
23	Low Oil Level		1, 2 <sup>(2)</sup> , 3	Hydraulic oil level is to low	Fill more hydraulic oil to the hydraulic tank.
24	Warning Return Filter	Yes	2 <sup>(2)</sup> , 3		Return filter element required replacing.
25	Warning Pressure Filter	Yes	2 <sup>(2)</sup> , 3		Pressure filter element required replacing.
26	Warning High Speed	Yes	1, 2 <sup>(2)</sup> , 3	"WARNING! High Speed. Stabilizer not active!"	
27	Stabilizer Fault	Yes	1, 2 <sup>(2)</sup> , 3	Any Stabilizer alarm.	See stabilizer panel for more info.
28	AC Motor Overtemp	Yes	1, 2 <sup>(2)</sup> , 3	"Hydraulic AC motor power pack overtemp. Higher than 120°C/248°F."	Stop running and wait for temperature to drop.
29	AC Motor Sensor Fail		2 <sup>(2)</sup> , 3	"Hydraulic AC motor power pack temp sensor open circuit"	Check sensor cables.
30	Temperature Warning	Yes	2 <sup>(2)</sup> , 3 <sup>(2)</sup>	High temperature warning.	Warns that the motor temperature is getting high.
31	Motor Overtemp	Yes	1, 2 <sup>(2)</sup> , 3	High temperature Alarm.	See SAC manual for more details.
32	VFD Warning	Yes	2 <sup>(2)</sup> , 3	There is an warning from VFD.	Check VFD for more details.
33	VFD Not Ready	Yes	2 <sup>(2)</sup> , 3	The VFD is not ready.	Check VFD for more details.
34	VFD Fault		1, 2 <sup>(2)</sup> , 3	VFD has an Alarm.	Check VFD for more details.
35	Warning Low Voltage	Yes	2 <sup>(2)</sup> , 3 <sup>(2)</sup>	Low motor voltage warning when motor is running. 12V thruster below 9.30V 24V thruster below 17.50V	
36	Not Calibrated	Yes	2 <sup>(2)</sup> , 3	Shaft Not Calibrated	See manual for how to calibrate.
37	VFD Com. Fault		2 <sup>(2)</sup> , 3	No Modbus communication with VFD	Check VFD Modbus cables and power.
38	Cooling Fan Fault		2 <sup>(2)</sup> , 3	Cooling fan stopped running, or running too slow	Device must be sent for service
39	Interlock		2 <sup>(2)</sup> , 3	S-link communication between PPC and retract controller are missing	-Check PPC or retract controller has power. -Check S-Link connections to PPC and retract controller. -Check if not PPC or SR150000/SR61242 is wrongly setup as SRP or SRVP/SRLP.

1. PPC520, PPC820, PPC800, PPC840

2. Buzzer is only activated when any device is sending thrust on the S-link bus.

Fault Code	Description	Cause	Action
10500.0.10	PHC Oil Level - Level Low	Hydraulic oil level is low	-Limit the use of thruster -Inspect hydraulic oil level -Check system for leaks and refill hydraulic oil
10500.0.13	PHC Oil Level - Open Circuit	Analog oil level sensor open circuit	-Sensor not connected or wire break. -Verify sensor type in parameter 0201 -Disconnect sensor and measure that sensor resistance value is in range 0-180ohm.
10501.0.11	PHC Oil Temp - Level High	Oil temperature higher than 75°C (167°F)	-Limit the use of thruster to prevent temperature to rise. -Check if the cooling pump is running and there is cooling water flow. -Inspect seawater filter -Verify that cooling pump is enabled in parameter 0301
10501.0.13	PHC Oil Temp - Open Circuit	Analog oil temp sensor open circuit	-Sensor not connected or wire break. - Disconnect sensor and measure that sensor resistance value is in range 104ohm-147Kohm -The wrong sensor is defined in parameter 0201
10501.0.16	PHC Oil Temp - Short Circuit	Analog oil temp input short circuit	-Input shorted to GND, check wiring/sensor -Disconnect sensor and measure that sensor resistance value is in range 104ohm-147Kohm
10502.0.13	PHC Stabilizer Pressure - Open Circuit	Stabilizer pressure sensor open circuit	-Sensor not connected or wire break. -System incorrectly configured with stabilizer, parameter 1001 -Replace sensor
10502.0.16	PHC Stabilizer Pressure - Short Circuit	Stabilizer pressure sensor short circuit	-Wires shorted or sensor defective, check wiring/sensor -Replace sensor
10502.0.19	PHC Stabilizer Pressure - Under Limit	Stabilizer pressure has dropped below 20bar.	-Check accumulator charge pressure -Check PTO pressure (if PTO powered) -Check system for oil leaks
10502.0.20	PHC Stabilizer Pressure - Over Limit	Stabilizer pressure is higher than: set point + 30bar running from PTO or set point + 15bar running from AC motor	-Check PTO pressure setting -Check accumulator charge pressure
10502.0.26	PHC Stabilizer Pressure - VALUE MAX	Stabilizer pressure reached sensor max value.	-Check that the correct sensor is fitted -Check that sensor range parameter 1010 match the sensor -Check PTO pressure setting
10502.0.200	PHC Stabilizer Pressure - Timeout	Stabilizer pressure has not reached 50% of setpoint parameter 1003 after 30sec.	-Check the pump feed shutoff valve. -Check PTO pressure (if PTO powered) -Check system for oil leaks
10503.0.13	PHC System Pressure - Open Circuit	System pressure sensor open circuit	-Sensor not connected or wire break. -Verify system pressure, parameter 0104
10503.0.16	PHC System Pressure - Short Circuit	System pressure sensor short circuit	-Wires shorted or sensor defective, check wiring/sensor -Replace sensor
10504.0.13	PHC AI 1 - Open Circuit	Analog Input 1 (4-20mA) sensor open circuit	-Sensor not connected or wire break.
10504.0.16	PHC AI 1 - Short Circuit	Analog Input 1 (4-20mA) sensor short circuit	-Wires shorted or sensor defective, check wiring/sensor -Replace sensor
10505.0.13	PHC AI 2 - Open Circuit	Analog Input 2 (4-20mA) sensor open circuit	-Sensor not connected or wire break.
10505.0.16	PHC AI 2 - Short Circuit	Analog Input 2 (4-20mA) sensor short circuit	-Wires shorted or sensor defective, check wiring/sensor -Replace sensor
10508.0.13	PHC DOUT AC PUMP UNLOAD - Open Circuit	AC Pump Unload valve open circuit	-Check for open circuit, power consumption < 5.0 Watt -System incorrectly configured with stabilizer, parameter 1001
10508.0.51	PHC DOUT AC PUMP UNLOAD - Current High	AC Pump Unload valve current higher than 4.0A	-Check wires and connections for short circuit
10509.0.13	PHC DOUT ACCUMULATOR DUMP - Open Circuit	Accumulator Dump valve open circuit	-Check for open circuit, power < 5.0 Watt -System incorrectly configured with stabilizer, parameter 1001
10509.0.51	PHC DOUT ACCUMULATOR DUMP - Current High	Accumulator Dump valve current higher than 4.0A	-Check wires and connections for short circuit
10510.0.13	PHC DOUT STABILIZER - Open Circuit	Stabilizer valve open circuit	-Check for open circuit, power consumption < 5.0 Watt -System incorrectly configured with stabilizer, parameter 1001
10510.0.51	PHC DOUT STABILIZER - Current High	Stabilizer valve current higher than 4.0A	-Check wires and connections for short circuit
10511.0.13	PHC DOUT COOLING PUMP HYDRAULIC - Open Circuit	Hydraulic Cooling Pump valve open circuit	-Check for open circuit, power consumption < 5.0 Watt -Wrong cooling pump configured, parameter 0301
10511.0.51	PHC DOUT COOLING PUMP HYDRAULIC - Current High	Hydraulic Cooling Pump valve current higher than 4.0A	-Check wires and connections for short circuit
10512.0.13	PHC DOUT LS DUMP - Open Circuit	LS-Dump valve open circuit	-Check for open circuit, power consumption < 5.0 Watt -System wrong configured with thrusters, parameter 2001 or 2101
10512.0.51	PHC DOUT LS DUMP - Current High	LS-Dump valve current higher than 4.0A	-Check wires and connections for short circuit
10513.0.51	PHC DOUT PUMP #2 - Current High	Pump #2 valve current higher than 4.0A	-Check wires and connections for short circuit
10514.0.13	PHC DOUT 5 - Open Circuit	Digital Output 5 is configured as crossover and output is open circuit	-Check for open circuit, power consumption < 5.0 Watt -Output configured wrong, parameter 0505
10514.0.51	PHC DOUT 5 - Current High	Digital Output 5 current higher than 4.0A	-Check wires and connections for short circuit
10515.0.13	PHC DOUT 6 - Open Circuit	Digital Output 6 is configured as crossover and output is open circuit	-Check for open circuit, power consumption < 5.0 Watt -Output configured wrong, parameter 0506
10515.0.51	PHC DOUT 6 - Current High	Digital Output 6 current higher than 4.0A	-Check wires and connections for short circuit
10516.0.13	PHC DOUT 3 - Open Circuit	Digital Output 3 is configured as crossover and output is open circuit	-Check for open circuit, power consumption < 5.0 Watt -Output configured wrong, parameter 0503
10516.0.51	PHC DOUT 3 - Current High	Digital Output 3 current higher than 4.0A	-Check wires and connections for short circuit

Fault Code	Description	Cause	Action
10517.0.13	PHC DOUT 2 - Open Circuit	Digital Output 2 is configured as crossover and output is open circuit	-Check for open circuit, power consumption < 5.0 Watt -Output configured wrong, parameter 0502
10517.0.51	PHC DOUT 2 - Current High	Digital Output 2 current higher than 4.0A	-Check wires and connections for short circuit
10518.0.13	PHC DOUT 1 - Open Circuit	Digital Output 1 is configured as crossover and output is open circuit	-Check for open circuit, power consumption < 5.0 Watt -Output configured wrong, parameter 0501
10518.0.51	PHC DOUT 1 - Current High	Digital Output 1 current higher than 4.0A	-Check wires and connections for short circuit
10519.0.13	PHC DOUT 4 - Open Circuit	Digital Output 4 is configured as crossover and output is open circuit	-Check for open circuit, power consumption < 5.0 Watt -Output configured wrong, parameter 0504
10519.0.51	PHC DOUT 4 - Current High	Digital Output 4 current higher than 4.0A	-Check wires and connections for short circuit
10520.0.51	PHC ECI PUMP POWER FEED - Current High	ECI cooling pump power current higher than 8.0A	-Check pump cable for damage and short circuits -Make sure the connector on the cooling pump is correctly inserted. -Replace cooling pump
10521.0.51	PHC Bow Thruster Power - Current High	Bow thruster PVG feed current higher than 3.0A	-Check PVG wires and connections for short circuit
10522.0.51	PHC Stern Thruster Power - Current High	Stern thruster PVG feed current higher than 3.0A	-Check PVG wires and connections for short circuit
10523.0.51	PHC Thruster Power - Current High	Bow or Stern PVG feed current higher than 3.3A	Check all bow and stern PVG signal wires for short circuits
10524.0.51	PHC ECI Cooling Pump - Current High	ECI cooling pump current higher than 13.0A	-Check ECI cooling pump cable for damage and short circuits -Replace ECI cooling pump
10524.0.53	PHC ECI Cooling Pump - Overvoltage	ECI cooling pump overvoltage, voltage higher than 33.0V	-Check PHC-3 input voltage is below 33.0V -Replace ECI cooling pump
10524.0.54	PHC ECI Cooling Pump - Undervoltage	ECI cooling pump under voltage, voltage is lower than 18.0V	-Check PHC-3 input voltage is higher than 18.0V -Replace ECI cooling pump
10524.0.55	PHC ECI Cooling Pump - Overtemp	ECI cooling pump temperature higher than 100°C (212°F)	-Check ECI cooling pump for damages -Replace ECI cooling pump
10524.0.100	PHC ECI Cooling Pump - No Communication	No communication with ECI cooling pump	-Check if ECI pump is connected -Check wires to ECI pump for open circuits -Check power supply cooling pump -Wrong cooling pump configured, parameter 0301
10524.0.205	PHC ECI Cooling Pump - HW FAULT	ECI cooling pump hardware fault	-Replace ECI cooling pump
10526.0.0	PHC ECI Cooling Pump Blocked - -	ECI cooling pump is blocked	-Reset fault and if fault reappears, cooling pump need service or replacement. -Check pump inlet for obstacles
10527.1.0	PHC VFD Not Ready Instance 1 -	VFD not ready	-VFD external run enable/power available signal is lost.
10528.1.10	PHC VFD ABB Parameter Instance 1 Level Low	ABB ACS550 parameter values 2001 or 2002 cannot be a negative value.	-Check ABB ACS550 parameter 2001 and 2002.
10529.0.19	PHC ECI Cooling Pump Speed - Under Limit	ECI pump motor speed under limit, below 100rpm	-Check hose for dirt -Check pump inlet for obstacles
10530.0.201	PHC PTO ENGINE INSTANCE - INIT FAIL	Parameter 1011-PTO ENGINE INSTANCE is not defined	-Set parameter 1011-PTO ENGINE INSTANCE
36000.1.24	ABB ACS550 Instance 1 Fault	ABB ACS550 fault	See ABB ACS550 drive for more details
36002.1.24	VACON Instance 1 Fault	VACON VFD Fault	See VACON drive for more details
36100.1.100	VFD Instance 1 No Communication	Lost communication with VFD	-VFD not powered up -VFD communication cable not connected or incorrectly wired
36103.1.0	VFD IN LOCAL Instance 1 -	VFD in local mode.	-Switch VFD to remote mode

Fault Code	Description	Cause	Action
10600.0.208	SR150000 Fault - INTERLOCK	Retract Interlock	-Check if retract is deployed. -No communication with Retract Controller, check Retract Controller has power. -Check PDC-301 and Retract Controller setup.
36100.1.24	VFD Instance 1 Fault	VFD faulted	-See VFD for more information
36100.1.100	VFD Instance 1 No Communication	PDC-301 has no MODBUS communication with VFD.	-Check communication cable with VFD -Check if VFD has power
36101.1.200	VFD PMS Instance 1 Timeout	VFD is not ready within 60 after power request.	-Check if VFD has power
36101.1.204	VFD PMS Instance 1 SIGNAL LOST	Lost Power Management signal from VFD, VFD not available anymore.	-Check VFD for more information.
36103.1.0	VFD IN LOCAL Instance 1 -	VFD in Local or Hand Mode	-Change mode in VFD panel.

**! Please refer to the graphic for special considerations relating to your model !**

**As a part of the seasonal service of your Thruster before every season, always check that:**

- The propeller is fastened securely to the gear leg.
- Bolts holding the thruster components together are fastened securely.
- The area around the thruster is clean and dry. Ensure there are no signs of water.
- Paint the propeller and gear leg with antifouling before every season to keep it clean from sea growth. **(NB: Never paint the anode, sealings or propeller shaft. Ensure paint does not enter the space between the propeller and the gear leg.)**
- Change the zinc anode before every season, or when half the anode has eroded. Always use a sealant or thread glue on the holding screw to ensure that it does not fall off. **(NB: In some water conditions, it may be necessary to install an extra zinc anode to ensure that it lasts for the whole period between regular service lifts of the boat. Consult your dealer for information on how to do this.)**
- All electrical connections are clean and fastened firmly.
- Ensure that your batteries are in good condition.  
\*While running the thruster measure volt output is greater than  
(10.5v) for 12v motors  
(21v) for 24v motors
- **OIL LUBRICATION GEAR LEGS:** There must always be oil in the oil reservoir. Refill if necessary with gear oil EP90. Change the gear oil a minimum of every second year. Check the gear oil quality in the gear house every time the boat is out of the water.

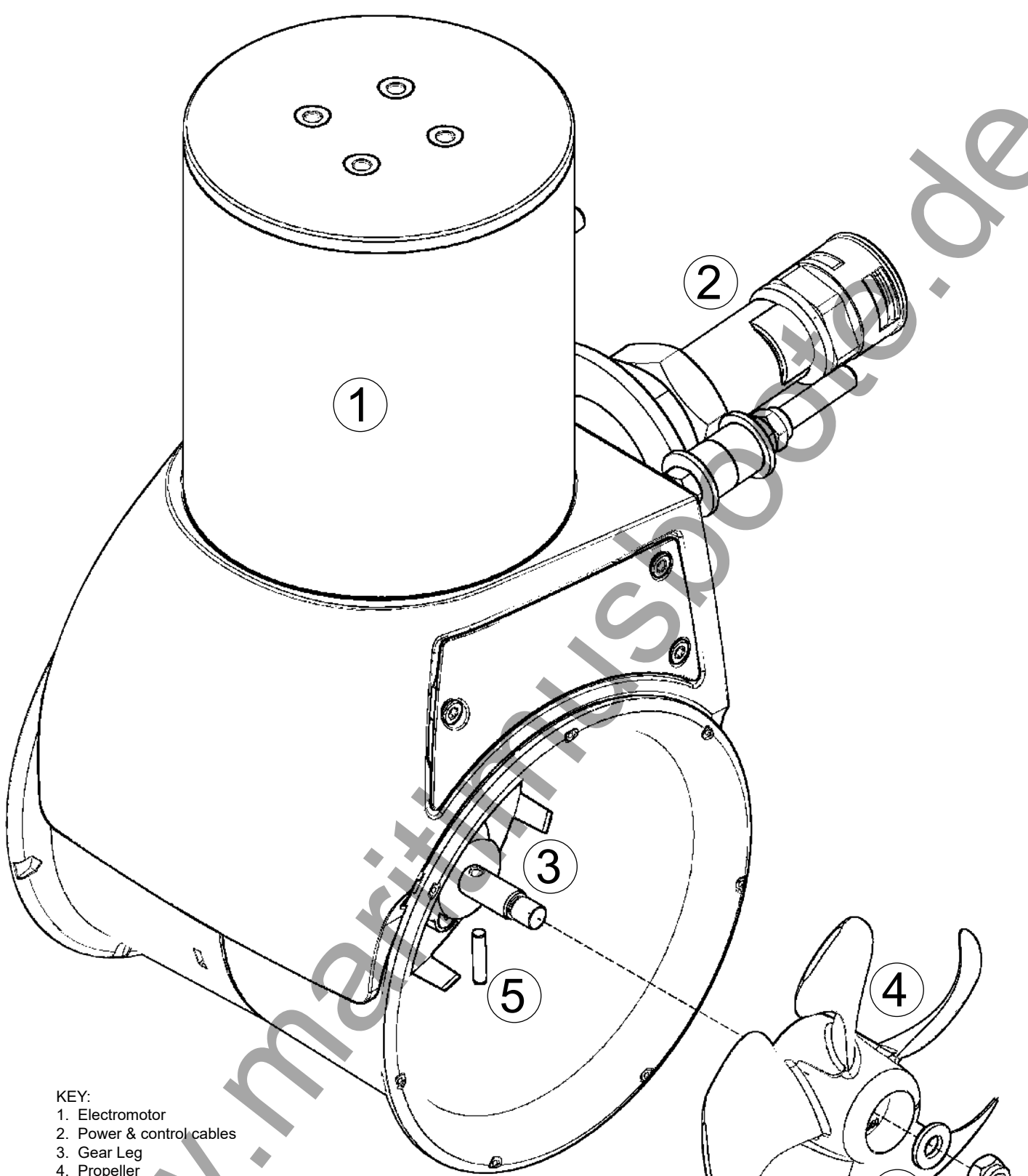

KEY:

- 1. Electromotor
- 2. Power & control cables
- 3. Gear Leg
- 4. Propeller
- 5. Drive pin
- 6. Washer
- 7. Lock Nut



Before seeking assistance at the help desk from your Side-Power dealer/ distributor, please perform these tests.

**(NB: All checkpoints and solutions must be carried out after consulting the relevant information elsewhere in this manual to understand how the system is intended to work. If you are unable to understand what to check, you must consult a professional.)**

CHECK	SOLUTION
<b>The electromotor runs, but there is no thrust</b>	
Check propellers are fastened correctly on the prop shaft	Re-fasten or replace if necessary
With the motor removed turn the driveshaft to ensure gears are turning the prop shaft to identify if failure is inside the gear house.	In case of failure inside the gear house, we advise replacing the gear house instead of attempting to repair the internal gear and bearing system.
*Check the flexible coupling, and shear pin between the motor and driveshaft is fitted correctly	Replace if necessary
<b>The thrusters performance is working lower than expected</b>	
Check brush-springs sit correctly on the brushes in the electromotor	If one or more brushes are loose or has no tension from the brush-spring, the performance will be low.
Check the propeller, gear house and tunnel are free from growth/ barnacles or debris	If there is growth in the tunnel, this will disturb/ block the water flow and significantly reduce performance
<u>While in use</u> , check the voltage of the electromotor is not lower than the specified amount. The voltage when in use should be: = 10,5V system = 21V system - If running at below voltage:	<b>(NB: Keep the main engine(s) running in use to have a continuous charge to the batteries)</b> <ul style="list-style-type: none"> <li>• Check batteries are worn out or in a bad charged condition</li> <li>• Check electrical connections/ wiring for damage or wear (corrosion)</li> <li>• Check cables are the correct size per the product manual</li> <li>• Tighten/ re-adjust connections</li> </ul> } Replace if necessary
<b>The thruster does not start/ works in only one direction</b>	
Check the voltage of the electromotor is correct for your installation and model.	If wrong, contact your dealer or distributor to obtain parts with the correct voltage.
<u>When not in use</u> , check the voltage at the thruster. The voltage when not in use should be: = 12V system @ 12,7 V (not below 12,3V) = 24V system @ 25,4 V (not below 24,6V) - If running at below voltage: <b>(NB: if less than 8V the thruster cannot operate)</b>	<ul style="list-style-type: none"> <li>• Check batteries are worn out or in a bad charged condition</li> <li>• Check electrical connections/ wiring for damage or wear (corrosion)</li> <li>• Check cables are the correct size per the product manual</li> <li>• Tighten/ re-adjust connections</li> </ul> } Replace if necessary
<u>IF</u> the main solenoids in the thruster are not trying to engage (clicking) the thruster might not be receiving a "run" signal from the control panel. Try to run the thruster without the control panel by directly connecting the red and blue or red and grey wires in the control cable contact end coming from the thruster.	<ul style="list-style-type: none"> <li>• <u>IF</u> the thruster runs in both directions, repeat the same process at the connector going into the back of the control panel.</li> <li>~ If it also works in this position, check the contact and wiring on the back of the panel and engage the thruster again by pushing both ON buttons simultaneously</li> <li>• <u>IF</u> the panel does not turn on (see control light), measure the voltage between the Red and the Black cable at the contact point going into the thruster.</li> <li>~ If the voltage is good, the chances are that the panel is not working.</li> <li>~ If it works by the thruster, not by the panel, there is a bad contact or broken cables between these two test points.</li> <li>• Measure that you have the correct voltage between the Red (+) and all the other colours in the contact.</li> </ul>
<u>IF</u> The thruster does not run at all, or only in one direction from the above tests, check the internal wiring on the thruster motor, solenoids and electronic motor interface box in accordance with the wiring diagram in the installation manual and ensure that all connections are clean and tight.	<ul style="list-style-type: none"> <li>• Between the main negative (A1 on motor) and the blue and the grey wires connected to the sides of the main solenoids, the voltage should be the same as between the main battery cables on the thruster.</li> <li>~ If not, check that the internal wiring on the solenoid and measure that there is contact through the magnetising spools of each side of the solenoid <b>(NB: test between the red and blue on one side, and the red and grey on the other side with an Ohm meter.)</b></li> <li>~ If there is no contact between these, the solenoid is broken and needs replacing.</li> </ul>
The thruster is not shutting off after the Joy Stick/ panel is disengaged If using a nonproportional thruster.	check electric contacts or control box for water/ corrosion damage, or it could be a mechanical problem with the main solenoid reacting slowly.
<b>The thruster runs for approximately 0,5 seconds every 4 seconds</b>	
probable cause is low voltage to the thruster	<ul style="list-style-type: none"> <li>• Check batteries if needed recharge</li> <li>• Check electrical connections/ wiring for damage or wear (corrosion)</li> <li>• Check cables are the correct size per the product manual</li> <li>• Tighten/ re-adjust connections</li> </ul> } Replace if necessary
<b>The thruster runs for approximately 0,5 seconds every 10 seconds</b>	
The solenoid might be in a lock-in/ auto stop position.	<ul style="list-style-type: none"> <li>• Shut off thrusters main switch, tap slightly on the motor to release the solenoid pin. Turn on the main thruster switch and test again, If the solenoid is still in a lock-in position, contact your dealer.</li> </ul>

\* Not applicable to SX thrusters.

CHECK TO PERFORM	DATE												
The propeller is fastened securely to the gear leg.													
Bolts holding the thruster components together are fastened securely.													
The area around the thruster is clean and dry. If there are signs of water, try to find the source and eliminate it.													
Paint the propeller and gear leg with antifouling.													
batteries are in good condition.													
All electrical connections are clean and fastened firmly.													
Check the drive shaft in the retract mechanism is lubricated.													
Check for excess movement in the break-away rings securing the actuator.													
Change the zinc anode.													
Check Rubber element for leakages. *REPLACE EVERY 3 YEARS													
Check oil in the oil reservoir. *REPLACE EVERY 2 YEARS													

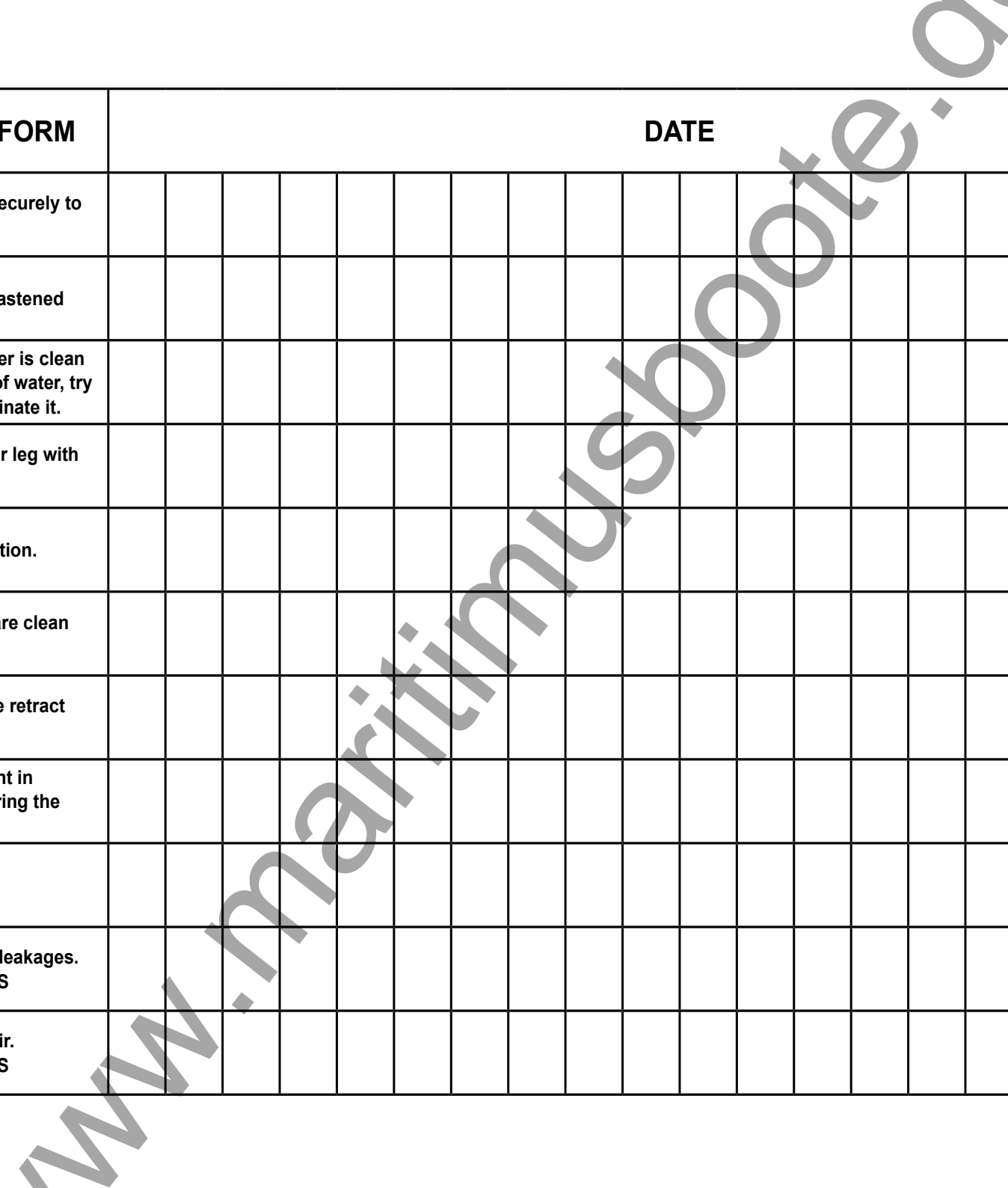

For the most up to date documentation, we advise you to visit our website [www.maritimusboote.de](http://www.maritimusboote.de) for the spare parts list.

1. The equipment manufactured by Sleipner Motor AS (The "Warrantor") is warranted to be free from defects in workmanship and materials under normal use and service.
2. This Warranty is in effect for of two years (Leisure Use) or one year (Commercial use) from the date of purchase by the user. Proof of purchase must be included, to establish that it is inside the warranty period.
3. This Warranty is transferable and covers the product for the specified time period.
4. In case any part of the equipment proves to be defective, other than those parts excluded in paragraph 5 below, the owner should do the following:
  - (a) Prepare a detailed written statement of the nature and circumstances of the defect, to the best of the Owner's knowledge, including the date of purchase, the place of purchase, the name and address of the installer, and the Purchaser's name, address and telephone number;
  - (b) The Owner should return the defective part or unit along with the statement referenced in the preceding paragraph to the warrantor, Sleipner Motor AS or an authorized Service Centre, postage/shipping prepaid and at the expense of the Purchaser;
  - (c) If upon the Warrantor's or Authorized Service Centre's examination, the defect is determined to result from defective material or workmanship, the equipment will be repaired or replaced at the Warrantor's option without charge, and returned to the Purchaser at the Warrantor's expense;
  - (d) no refund of the purchase price will be granted to the Purchaser, unless the Warrantor is unable to remedy the defect after having a reasonable number of opportunities to do so. Prior to refund of the purchase price, Purchaser must submit a statement in writing from a professional boating equipment supplier that the installation instructions of the Installation and Operation Manual have been complied with and that the defect remains;
  - (e) warranty service shall be performed only by the Warrantor, or an authorized Service Centre, and any attempt to remedy the defect by anyone else shall render this warranty void.
5. There shall be no warranty for defects or damages caused by faulty installation or hook-up, abuse or misuse of the equipment including exposure to excessive heat, salt or fresh water spray, or water immersion except for equipment specifically designed as waterproof.
6. No other express warranty is hereby given and there are no warranties which extend beyond those described in section 4 above. This Warranty is expressly in lieu of any other expressed or implied warranties, including any implied warranty of merchantability, fitness for the ordinary purposes for which such goods are used, or fitness for a particular purpose, and any other obligations on the part of the Warrantor or its employees and representatives.
7. There shall be no responsibility or liability whatsoever on the part of the Warrantor or its employees and representatives for injury to any person or persons, or damage to property, loss of income or profit, or any other consequential or resulting damage or cost which may be claimed to have been incurred through the use or sale of the equipment, including any possible failure or malfunction of the equipment, or part thereof.
8. The Warrantor assumes no liability for incidental or consequential damages of any kind including damages arising from collision with other vessels or objects.
9. This warranty gives you specific legal rights, and you may also have other rights which vary from country to country.

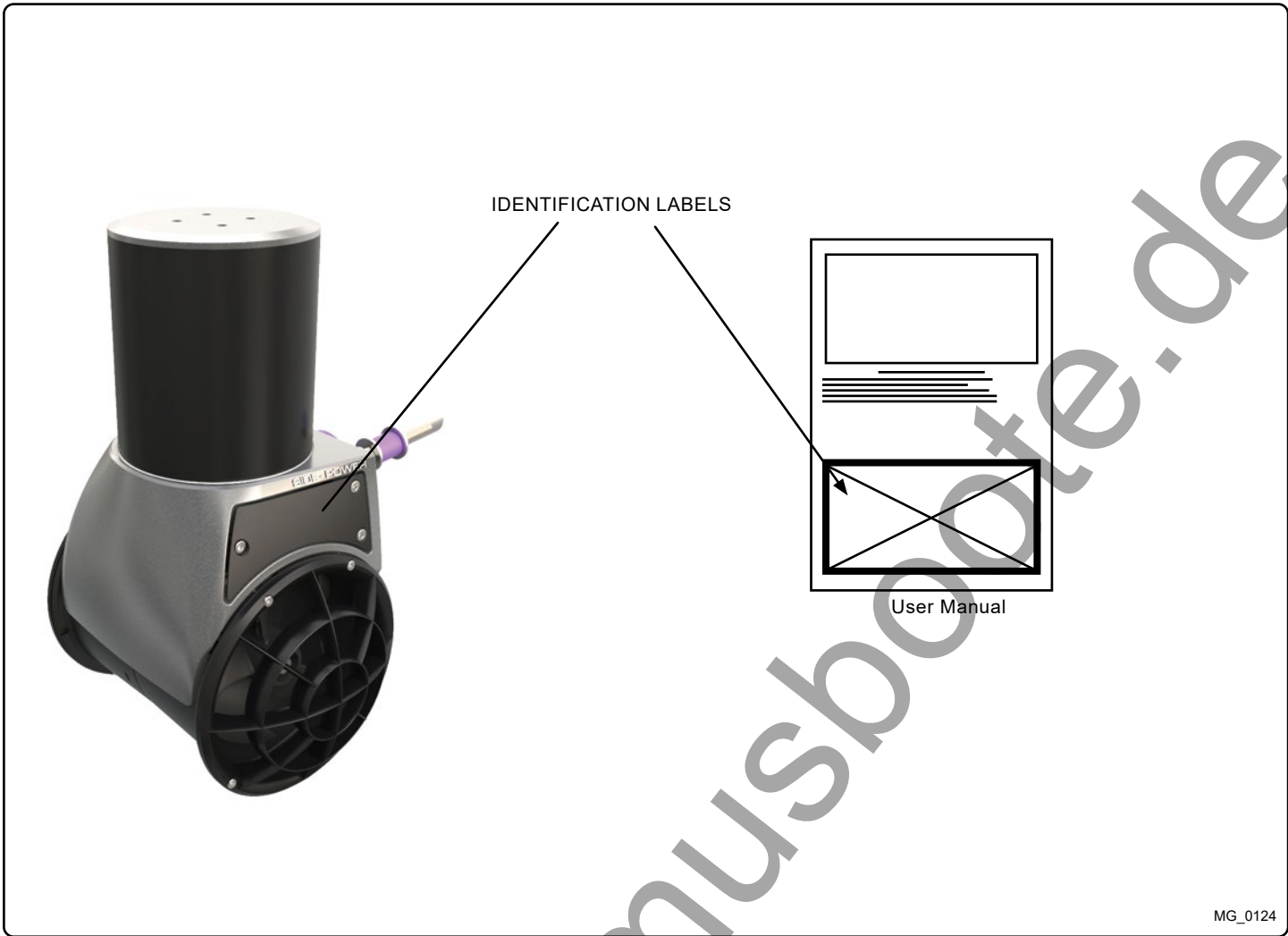

MG\_0124

EN

## Identifying your Product

MC\_0080

**! Please refer to the graphic for special considerations relating to your model !**

Sleipner Side-Power products are shipped with a unique identification code and registered in our database for future service and repair assistance.

To find additional product information search the serial number attached in this manual below or from the sticker on the motor installed in your vessel.

EN

## Products Identification Code

MC\_0080

