

LC-R121R3P*1

FOR MAIN AND STANDBY POWER SUPPLIES.
 EXPECTED TRICKLE DESIGN LIFE: 6 - 9 YEARS AT 20°C
 ACCORDING TO EUROBAT.



G196049

DIMENSIONS (MM)



Terminal type

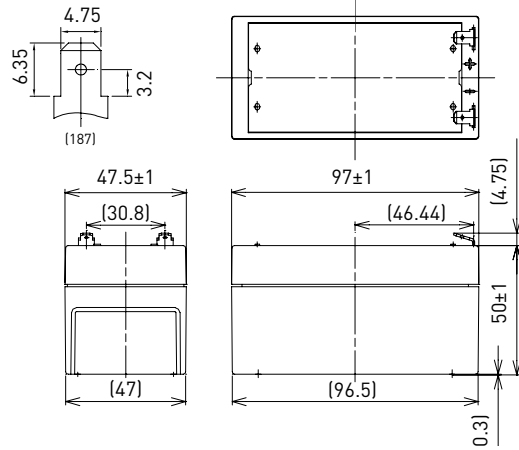

Contents indicated (including the recycle marking, etc.) are subject to change without notice.

Battery case resin: standard (UL94 HB)

SPECIFICATIONS		LC-R121R3PG*1
Name		LC-R121R3PG*1
Nominal voltage		6V
Nominal capacity (20 hour rate)		1.3Ah
Dimensions	Length	97mm
	Width	47.5mm
	Height	55mm
Approx. mass		0.55kg
Terminal		Faston 187
Capacity (25°C)	20 hour rate	1.3Ah
	10 hour rate	1.2Ah
	3 hour rate	1.1Ah
	1 hour rate	0.9Ah
Impedance	Fully charged battery (25°C)	90mΩ
	40°C	102%
Temperature dependency of capacity (20 hour rate)	25°C	100%
	0°C	85%
	-15°C	65%
Self-discharge (25°C)	After 3 month	91%
	After 6 month	82%
	After 12 month	64%

DURATION OF DISCHARGE VS. DISCHARGE CURRENT

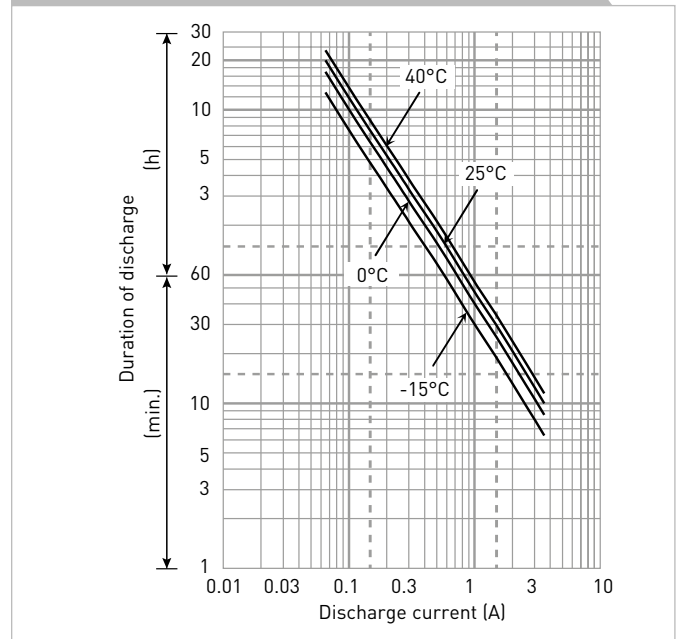

WATT TABLE (25°C)																(Wattage/battery)
Cut-off	3min.	5min.	10min.	15min.	20min.	30min.	45min.	1h	1.5h	2h	3h	4h	5h	6h	10h	20h
9.6V	78.1	61.6	40.2	30.7	25.8	19.2	13.6	10.8	7.49	5.73	4.32	3.30	2.73	2.22	1.46	0.787
9.9V	72.5	57.8	39.4	30.5	25.3	19.0	13.5	10.7	7.34	5.68	4.30	3.28	2.70	2.21	1.45	0.784
10.2V	66.9	54.2	38.4	29.9	24.9	18.8	13.4	10.6	7.19	5.54	4.25	3.26	2.68	2.19	1.44	0.782
10.5V	59.4	48.5	35.6	27.8	23.7	18.4	13.1	10.4	7.04	5.34	4.19	3.25	2.66	2.17	1.43	0.780
10.8V	50.2	42.9	31.7	26.0	23.0	17.7	12.9	10.2	6.82	5.13	4.08	3.24	2.60	2.16	1.41	0.758

AMPERE TABLE (25°C)																(Ampere/battery)
Cut-off	3min.	5min.	10min.	15min.	20min.	30min.	45min.	1h	1.5h	2h	3h	4h	5h	6h	10h	20h
9.6V	7.02	5.53	3.59	2.67	2.22	1.64	1.16	0.921	0.634	0.484	0.363	0.276	0.228	0.185	0.122	0.0655
9.9V	6.52	5.18	3.52	2.65	2.18	1.63	1.15	0.912	0.621	0.480	0.361	0.274	0.226	0.184	0.121	0.0654
10.2V	6.01	4.86	3.43	2.60	2.15	1.61	1.14	0.903	0.609	0.468	0.358	0.273	0.224	0.183	0.120	0.0652
10.5V	5.34	4.35	3.18	2.42	2.04	1.57	1.12	0.885	0.596	0.451	0.352	0.272	0.222	0.182	0.119	0.0650
10.8V	4.51	3.85	2.83	2.26	1.99	1.52	1.10	0.867	0.578	0.433	0.343	0.271	0.217	0.181	0.117	0.0632

All mentioned values are average values

LC-R121R3P*1

CHARGING METHOD (25°C)

Cycle use Control voltage: 14.5V - 14.9V
Initial current: 0.52A or smaller

CUT-OFF VOLTAGE

Discharge current	0.065A - 0.26A	0.26A - 0.65A	0.65A - 1.3A	1.3A - 2.6A	2.6A - 3.9A
Cut-off voltage	10.5V	10.2V	9.9V	9.3V	8.7V

CYCLE LIFE VS. DEPTH OF DISCHARGE (ACC. IEC 61056)

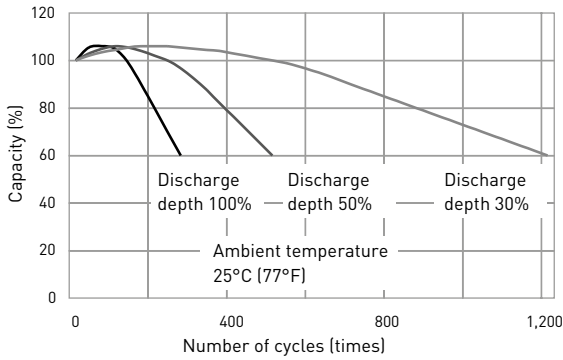

RESIDUAL CAPACITY TEST RESULT

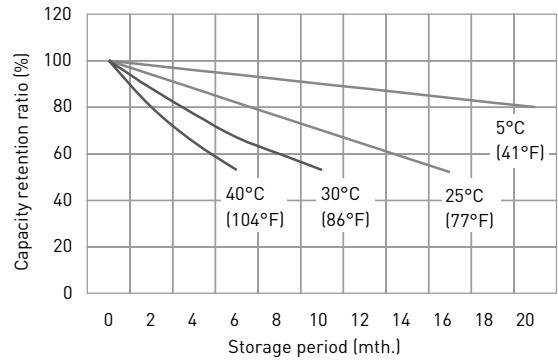

CONSTANT-VOLTAGE CONSTANT-CURRENT CHARGE CHARACTERISTICS FOR CYCLE USE

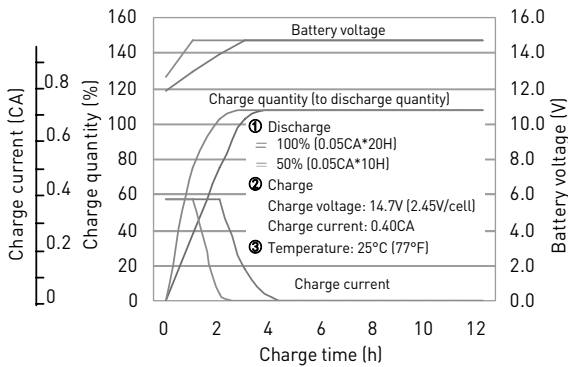

DISCHARGE CAPACITY BY TEMPERATURE AND BY DISCHARGE CURRENT

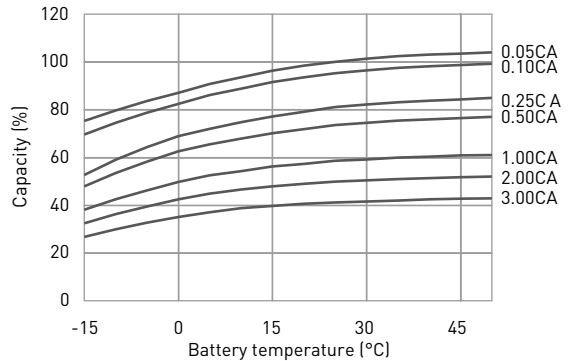

DISCHARGE CHARACTERISTICS

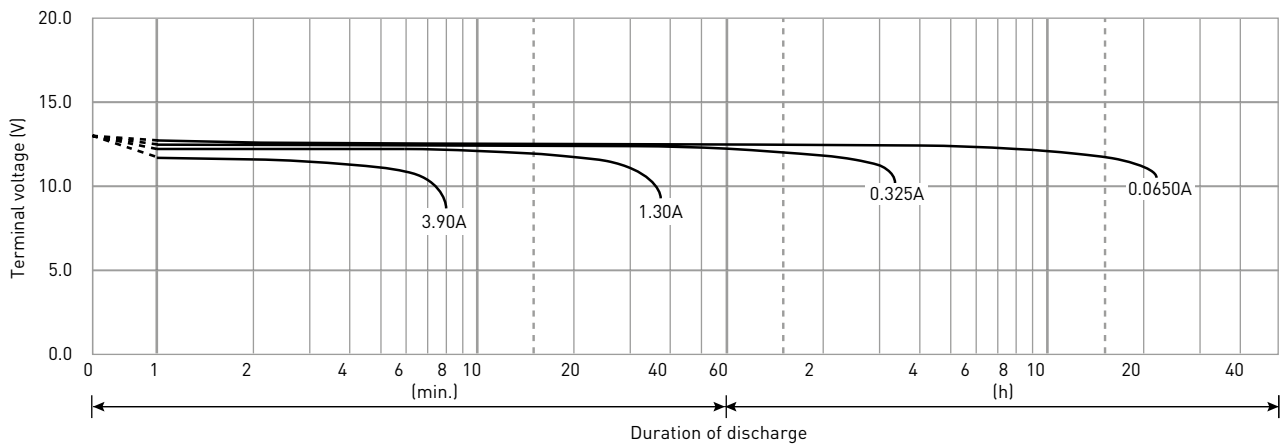

The data in this document are for descriptive purposes only and are not intended to make or imply any guarantee or warranty. Regarding handling and safety please consult our VRLA technical handbook chapter 1.

*1 This battery is also available with a flame retardant battery case resin (UL94 V-0): LC-V121R3PG.